

WHAT IS A STANDARD?

- A standard is a reference document providing answers to product-related technical or commercial problems that present themselves repeatedly in relations between economic, scientific or technical partners, etc.
- It is drawn up by consensus within standardisation bureaux (or organisations) by all volunteering economic operators.
- Standardisation assists dialogue between manufacturers, users, public authorities and other partners.
- Standardisation is essentially a technical activity serving an economic purpose. It helps to clarify transactions, rationalise production, and assist commercial exchanges.



EXTRACT FROM EUROPEAN STANDARD NF EN 45020

• Standard document established by consensus and approved by a recognised body, that provides, for common and repeated use, rules, guidelines for activities or their results, aimed at the achievement of the optimum degree of order in any given context.

ISO/IEC GUIDE 2

• A standard is a document established by consensus that provides, for common and repeated use, rules, guidelines for activities or their results, aimed at the achievement of the optimum degree of order in a given context

FACOM, 30 YEARS OF INVOLVEMENT IN INTERNATIONAL STANDARDISATION

- FACOM is actively involved in the various standardisation committees (French - NF, International - ISO or American ASME or SAE) for hand tools.
- FACOM's involvement at an early stage in the elaboration process allows it to continuously adapt its products to the requirements of future standards and provide tools of the required quality, ensuring greater ease and safety of use.
- FACOM informs its users by indicating the main standards applying to its tools :
 - European and International standards (EN / ISO)
 - French standards (NF)
 - German standards (DIN)
 - American standards (ASME / SAE)

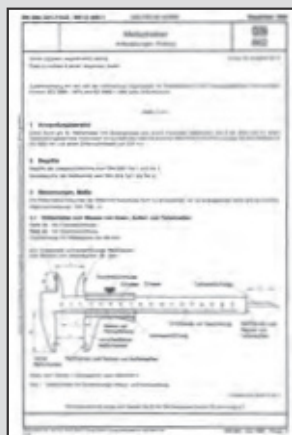
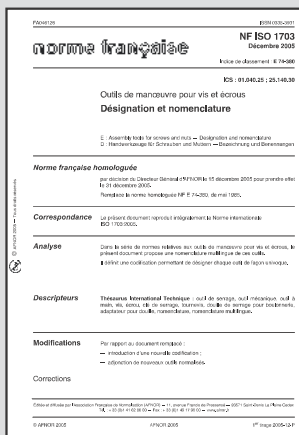

Extracts from the AFNOR standard. Only the full version of the standard has authority. It can be obtained from the Afnor Web site www.boutique-normes.afnor.org (DIN Standard) Reproduced by permission of DIN Deutsches Institut für Normung e.V. The definitive version for the implementation of this standard is the edition bearing the most recent date of issue, obtainable from Beuth Verlag GmbH, 10772 Berlin, Germany.

DIMENSIONS OF THE PH END PENETRATION GAUGE

End	a	b	c	e	f	m	α	β
no	± 0,005	min.	± 0,025	max.	± 0,005	0	-0°15'	+0°15'
	mm	mm	mm	mm	mm	mm		
0	0,419	3		2,38	0,284	0,29	-	7°
1	0,648	4,5		2,38	0,493	0,49	138°	
2	1,156	6	0,254	3,97	0,769	1,08	140°	5°45'
3	1,918	8		6,34	1,257	2,07	146°	
4	2,553	10		7,94	1,804	2,71	153°	7°

PH END GAUGES

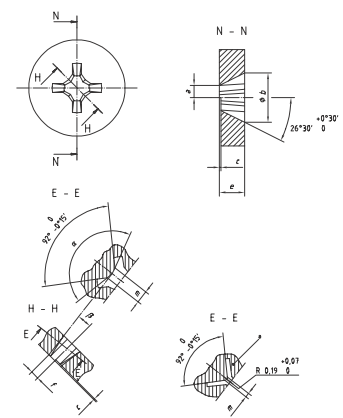

WRENCHES

Désignation New Old	Term	ISO standards	Tool	Use
1 1 01 01 0 1 1 01 01 1	1 Single open- end	4229 (691, 1711-1)		
1 1 01 02 0	4 Double open- end	10102 (691, 1085, 1711-1, 3318)		
1 1 01 03 0	3 Open-end slogging wrench	(691)		
1 1 01 04 0	2 Adjust- table wrench	6787		
1 1 01 05 0	13 Angled combi- nation wrench	7738 (691, 1711-1, 3318)		
1 1 01 06 0	14 Offset combi- nation wrench	7738 (691, 1711-1, 3318)		

MECHANICAL FITS

Fits are categories of standard tolerated dimensions that are used for assembling two cylindrical or prismatic parts.

STANDARD DESIGNATION AND MARKINGS

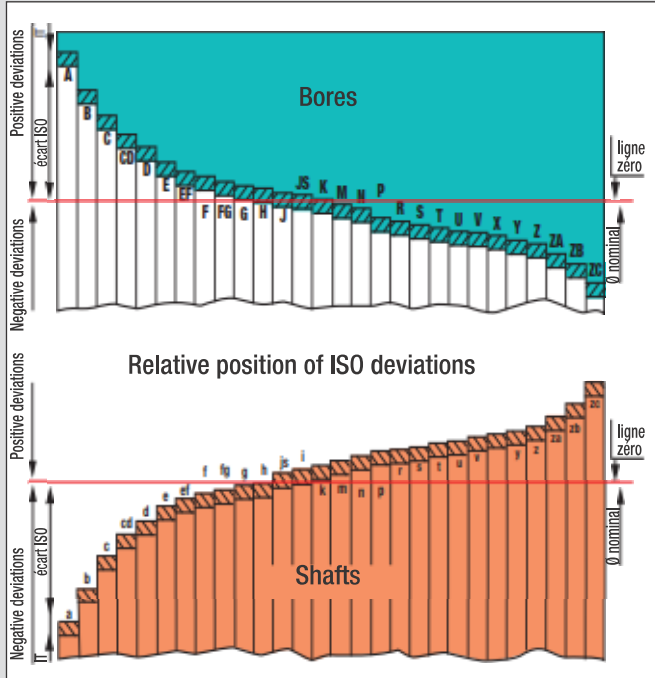

STANDARD FITS

		Standard fits (H bore system)								
Type	shaft	Bores						Comments		
		H6	H7	H8	H9	H10	H11			
Moving parts	high clearance	c11							Standard fits for long spans, poor alignment, expansion, etc.	
		c10								
		c9								
	medium clearance	d9							Standard fits for rotating or sliding guides (good lubrication ensured)	
		d8								
		e9								
		e8								
		f7								
		f6								
low clearance	g5							For high-precision guides		
	g6									
	g5									
Non-moving parts	adjusted	h9						Can be assembled by hand	For centring and locating, cannot transfer forces	Parts disassembled without damage
		h7								
		h6								
	highly adjusted	js7						Can be assembled with a mallet (Press recommended)		
		js6								
		js5								
	not very tight	k6						Assembled with a press	For transmission of forces	Parts damaged when disassembled
		k5								
		m7								
	tight	m6						Assembled with a heavy-duty press or by dilation (shrink-fitting)		
		n6								
		p6								
interference fits	r6									
	s7									
	s6									
very tight	t5									
	u6									
	x7									

most commonly used

most commonly used (to be known)

STANDARD TOLERANCE INTERVALS (OR QUALITIES)

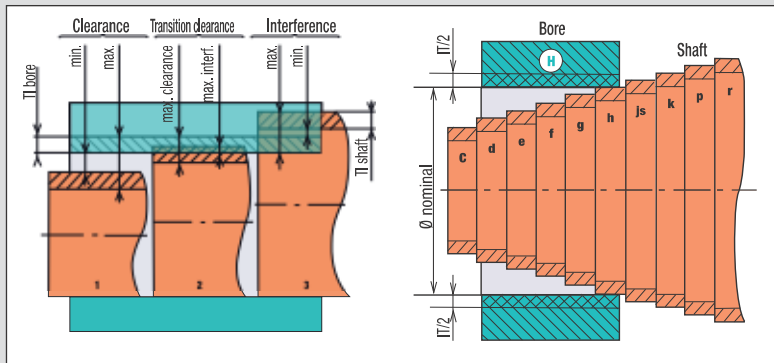

• Ajustements avec jeu :

Ø80 H8 f7
Jeu mini = 0.030 mm
Jeu Maxi = 0.106 mm

• Ajustements avec jeu incertain (jeu ou serrage) :

Ø80 H7 k6
Jeu Maxi = 0.009 mm
Serrage Maxi = 0.002 mm

• Ajustements avec serrage ou interférence :

Ø80 H7 p6
Serrage mini = 0.002 mm
Serrage Maxi = 0.051 mm

Main ISO qualities or tolerances (TI)
(IT in micrometres : 1µm = 0.001 mm)
Nominal dimensions (mm):

above → to (inclusive) →	1	3	6	10	18	30	50	80	120	180	250	315	400
IT5	4	5	6	8	9	11	13	15	18	20	23	25	27
IT6	6	8	9	11	13	16	19	22	25	29	32	36	40
IT7	10	12	15	18	21	25	30	35	40	46	52	57	63
IT8	14	18	22	27	33	39	46	54	63	72	81	89	97
IT9	20	30	36	43	52	62	74	87	100	115	130	140	155
IT10	40	48	58	70	84	100	120	140	160	185	210	230	250
IT11	60	75	90	110	130	160	190	220	250	290	320	360	400
IT12	100	120	150	180	210	250	300	350	400	460	520	570	630
IT13	140	180	220	270	330	390	460	540	630	720	810	890	970

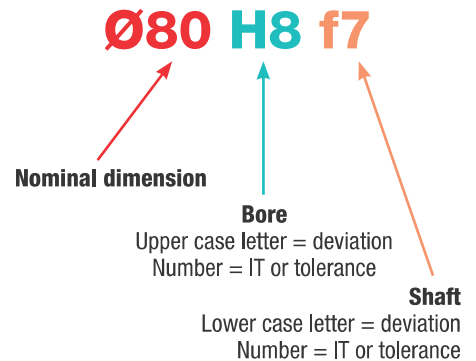

This data is published with the permission of AFNOR.

LIGHTING SAFETY

- It is essential to use the correct light for the situation to avoid tired eyes and accidents at work.
- Engineering or maintenance tasks require an illumination of 300 to 500 lux.
- Inspection, finishing and painting tasks require an illumination of 750 to 1000 lux.
- The light source must be designed and arranged to avoid uncomfortable glare.



IP INGRESS PROTECTION RATING

- The IP code indicates the degree of protection against access to hazardous parts, as well as the penetration of solid foreign bodies and of water.
- The code consists of two figures (e.g. IP 64), defined right according to NF EN 60529

IP rating: What does it mean?

1st FIGURE Protection of live components against ingress of solid objects		2nd FIGURE Protection of live components against ingress of liquids	
0	No protection	0	No protection
1	Solid objects greater than 50mm diameter cannot penetrate	1	Vertically falling drops of water
2	Solid objects greater than 12.5 mm diameter cannot penetrate	2	Water dripping on the enclosure tilted at 15° from its normal position
3	A steel wire of 2.5 mm diameter cannot penetrate	3	Spraying water at an angle of up to 60° from the vertical
4	A steel wire of 1 mm diameter cannot penetrate	4	Splashing water against the enclosure from any direction
5	Invisible amount of talcum powder deposited when tested in a dust chamber	5	Water projected in jets (6.3 mm) against the enclosure from any direction
6	No talcum powder deposited when tested in a dust chamber	6	Water projected in jets (12.5 mm) against the enclosure from any direction
		7	Immersion to 1 mm
		8	Submersible equipment according to manufacturer's specifications

THERE ARE A NUMBER OF LIGHTING TECHNOLOGIES TO CHOOSE FROM:

Technology	Advantages	Disadvantages	Lighting power	FACOM product
Fluorescent and compact fluorescent lamps  IP 55	Diffuse lighting, low temperature, low consumption	Average impact resistance	300 to 400 lux	777 range 
Leds IP 64	Very good impact resistance, low temperature, very low consumption, long operating life	Cost, concentrated light beam	500 to 1000 lux	779 range 



SAFETY RECOMMENDATIONS

- Use fluorescent inspection lamps complying with the requirements of EN 60 598-2-8.
- For mains powered lights, preferably choose inspections lamps powered at a voltage of less than 50V.

STANDARDISATION AND SELECTION GUIDE

SOCKETS



483



PLIERS



261



WRENCHES



197



TIPS



458



SCREWDRIVERS



416



CIRCLIPS®

External Circlips®

• Solit spring rings for shafts to NF E 22-163

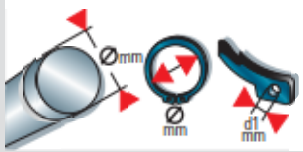

Standard range		
3 ▶ 5	2,7 ▶ 4,7	1
6 ▶ 9	5,6 ▶ 8,4	1,2
10 ▶ 13	9,3 ▶ 11,9	1,5
14 ▶ 17	12,9 ▶ 15,7	1,7
18 ▶ 30	16,5 ▶ 27,9	2
32 ▶ 63	31,5 ▶ 58,8	2,5
65 ▶ 82	60,8 ▶ 76,5	3
85 ▶ 120	82,5 ▶ 113	3,5
125 ▶ 200	118 ▶ 190,5	4

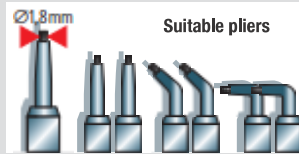

Ø	177A.9	167A.9	197A.9
0,9	177A.13	167A.13	197A.13
1,3	177A.18	167A.18	197A.18
1,8	177A.23	167A.23	197A.23
2,3	177A.32	167A.32	197A.32
3,2	177A.32	167A.32	197A.32

Heavy-duty range		
15 ▶ 30	13,8 ▶ 27,9	2
32 ▶ 60	29,6 ▶ 55,8	2,5
65 ▶ 80	60,8 ▶ 74,5	3
85 ▶ 100	79,5 ▶ 94,5	3,5

Internal Circlips®

• Solit spring rings for shafts to NF E 22-165

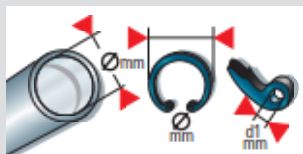

Standard range		
8 ▶ 3	8,7 ▶ 9,8	1
10 ▶ 11	10,8 ▶ 11,8	1,2
12 ▶ 13	13 ▶ 14,1	1,5
14 ▶ 17	15,1 ▶ 18,3	1,7
18 ▶ 30	19,5 ▶ 32,1	2
31 ▶ 63	33,4 ▶ 67,2	2,5
65 ▶ 82	69,2 ▶ 87,5	3
85 ▶ 120	90,5 ▶ 127	3,5
125 ▶ 200	135 ▶ 209,5	4

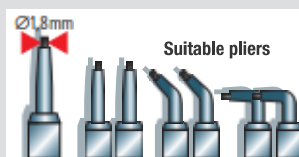

Ø	179A.9	169A.9	199A.9
0,9	179A.13	169A.13	199A.13
1,3	179A.18	169A.18	199A.18
1,8	179A.23	169A.23	199A.23
2,3	179A.32	169A.32	199A.32
3,2	179A.32	169A.32	199A.32

Heavy-duty range		
20 ▶ 30	21,5 ▶ 32,1	2
32 ▶ 62	34,4 ▶ 66,2	2,5
65 ▶ 80	69,2 ▶ 85,5	3
85 ▶ 100	90,5 ▶ 105,5	3,5

TIGHTENING TORQUES



368

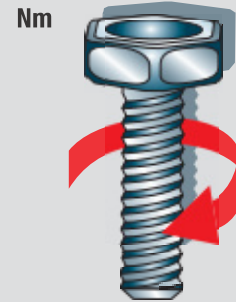

Diagram illustrating various screw and nut types with their corresponding tightening torque symbols:

- Circlips®**: Represented by a blue circlip icon.
- Hexagon heads**: Represented by a hex nut icon.
- Hexagon socket heads**: Represented by a hex socket head screw icon.
- Torx® heads**: Represented by a Torx head screw icon.
- Male Torx® heads**: Represented by a male Torx head screw icon.
- Slotted heads**: Represented by a slotted head screw icon.
- Vis à empreinte Phillips®**: Represented by a Phillips head screw icon.
- Pozidriv® heads**: Represented by a Pozidriv head screw icon.

Hexagon heads



• For inch to mm conversions, see "Inch dimensions".

Metric sizes (*recommended sizes)

Screw diameter ISO 272 Ø	Screw diameter ISO 272 Ø				Wrench size ISO 691	
	standardhead Ø mm	wide head Ø mm	collar screw Ø mm	collar nut	Min.	Max.
3,2*	1,6				3,22	3,28
3,5					3,52	3,58
4*	2				4,02	4,12
4,5					4,52	4,62
5*	2,5				5,02	5,12
5,5*	3				5,52	5,62
6					6,03	6,15
7*	4		5		7,03	7,15
8*	5		6	5	8,03	8,15
9					9,03	9,15
10*	6		8	6	10,04	10,19
11*	7				11,04	11,19
12					12,04	12,24
13*	8		10	8	13,04	13,24
14					14,05	14,27
15*			12	10	15,05	15,27
16*	10				16,05	16,27
17					17,05	17,30
18*	12		14	12	18,05	18,30
19					19,06	19,36
21*	14	12	16	14	21,06	21,36
22					22,06	22,36
23					23,06	23,36
24*	16	14		16	24,06	24,36
26					26,08	26,48
27*	18	16	20		27,08	27,48
29					29,08	29,48
30*	20	18		20	30,08	30,48
32					32,08	32,48
34*	22	20			34,10	34,60
35					35,10	35,60
36*	24	22			36,10	36,60
38					38,10	38,60
41*	27	24			41,10	41,60
42					42,10	42,60
46*	30	27			46,10	46,60
50*	33	30			50,10	50,60
54					54,12	54,72
55*	36	33			55,12	55,72
58					58,12	58,72
60*	39	36			60,12	60,72
63					63,12	63,72
65*	42	39			65,12	65,72
67					67,12	67,72
70*	45				70,12	70,72
71					71,15	71,85
75*	48				75,15	75,85
77					77,15	77,85
80*	52				80,15	80,85
82					82,15	82,85
85*	56				85,15	85,85
88					88,15	88,85
90*	60				90,15	90,85
94					94,15	94,85
95*	64				95,15	95,85
100*	68				100,15	100,85
105*	72				105,20	106,00
110*	76				110,20	111,00
115*	80				115,20	116,00
116					116,20	117,00
120*	85				120,20	121,00

Relationship screw diameter/size across flats

Inch sizes

Inch		mm		Screw diameter Ø		Thou. inch		mm	
Unified thread GB - USA - CANADA		Heavy series BS.1769 ASME B 18-2-1 18-2-2		Standard series BS.1768 ASME B 18-2-1 18-2-2		Machined or cast nuts		BSW BS. 916BSF 1083BSF	
BS. 1981									
							.117	2,97	
							.131	3,32	
1/8	3,17					2	.152	3,86	
							.172	4,37	
3/16	4,76					3-4-5	2-3	.193	4,90
7/32	5,56							.220	5,59
1/4	6,35					6-8	4	.248	6,30
9/32	7,14							.282	7,16
5/16	7,94					10-12	5-6	.324	8,23
11/32	8,73						8		
3/8	9,52						10	.365	9,27
7/16	11,11						1/4 - 12	.413	10,49
1/2	12,70	1/4 (1)	5/16					.445	11,30
9/16	14,29	5/16 (1)	3/8			5/16		.525	13,33
5/8	15,87		7/16			3/8		.600	15,24
11/16	17,46	3/8 (1)						.710	18,03
3/4	19,05	7/16 (1)	1/2						
13/16	20,64		9/16					.820	20,83
7/8	22,22	1/2						.920	23,37
15/16	23,81		5/8						9/16
1"	25,40								
1 1/16	26,99	5/8					1.010	25,65	5/8
1 1/8	28,57		3/4						
1 1/4	31,75	3/4					1.200	30,48	3/4
1 5/16	33,34		7/8				1.300	33,02	7/8
1 3/8	34,92								
1 7/16	36,51	7/8							
1 1/2	38,10		1"				1.480	37,59	1"
1 5/8	41,27	1"							
1 11/16	42,86		1 1/8				1.670	42,42	1 1/8
1 13/16	46,04	1 1/8							
1 7/8	47,62		1 1/4				1.860	47,24	1 1/4
2"	50,80	1 1/4							
2 1/16	52,39		1 3/8				2.050	52,07	1 3/8
2 3/16	55,56	1 3/8							
2 1/4	57,15						2.200	56,39	1 1/2
2 3/8	60,32	1 1/2	1 1/2				2.410	61,22	1 5/8 (4)
2 7/16	61,91								
2 9/16	65,09						2.580	65,53	1 3/4
2 5/8	66,67		1 3/4 (2)						
2 3/4	69,85	1 3/4					2.760	70,10	2"
2 13/16	71,44								
2 15/16	74,61								
3"	76,20		2" (2)						
3 1/8	79,37	2"					3.150	80,01	2 1/4 (4)
3 3/8	85,72		2 1/4 (3)						
3 1/2	88,90	2 1/4					3.550	90,17	2 1/2 (4)
3 3/4	95,25		2 1/2 (3)						
3 7/8	98,42	2 1/2					3.890	98,81	2 3/4 (4)
4 1/8	104,80		2 3/4 (3)						
4 1/4	107,95	2 3/4					4.180	106,20	3" (4)
4 1/2	114,30		3" (3)				4.530	115,06	3 1/4 (4)
4 5/8	117,50	3"							
							4.850	123,20	3 1/2 (4)
							5.180	131,60	3 3/4 (4)
							5.550	141	4" (4)
							6.380	162	4 1/2 (4)

For inch sizes
 (1) USA ASME B.18-2-2 only.
 (2) Except Norway.
 (3) Except Norway.
 (4) BSW BS 916 BSF only.

STANDARDISATION AND SELECTION GUIDE

HEXAGON SOCKET HEADS

Relationship screw diameter/hexagon socket size

Metric sizes

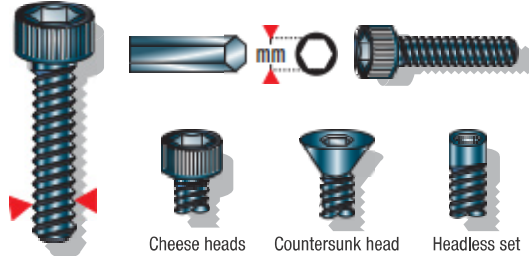

Ø Screw mm	Cheese heads screws ISO 4762	Countersunk head screws ISO 10642	Headless set screws ISO 4026
M1,6	1,5		0,7
M2	1,5		0,9
M2,5	2		1,3
M3	2,5	2	1,5
M4	3	2,5	2
M5	4	3	2,5
M6	5	4	3
M8	6	5	4
M10	8	6	5
M12	10	8	6
M14	12	10	
M16	14	10	8
M18	14		
M20	17	12	10
M22	17		
M24	19		12
M27	19		
M30	22		
M33	24		
M36	27		
M42	32		

Inch sizes

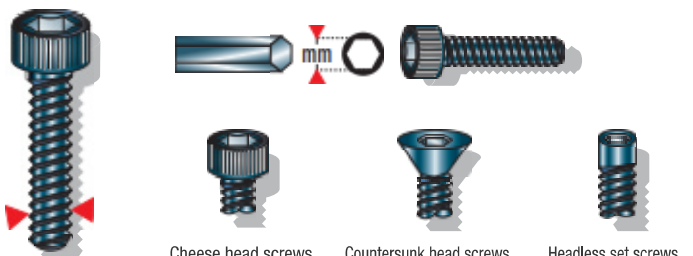

Ø Screw mm	"	mm	"	mm	"	mm	
n° 0	1,52	0,50	1,27	.035	0,89	.028	0,711
n° 1	1,85	1/16	1,59	.050	1,27	.035	0,89
n° 2	2,18	5/64	1,98	.050	1,27	.035	0,89
n° 3	2,51	5/64	1,98	1/16	1,59	.050	1,27
n° 4	2,84	3/32	2,38	1/16	1,59	.050	1,27
n° 5	3,17	3/32	2,5	5/64	1,98	1/16	1,59
n° 6	3,5	7/64	3	5/64	1,98	1/16	1,59
n° 7	3,5	1/8	4				
n° 8	4,16	9/64	5	3/32	2,38	5/64	1,98
n° 10	4,82	5/32	6	7/64	2,78	3/32	2,38
n° 10	4,82			1/8	3,17		
1/4	6,35	3/16	4,75	9/64	3,57	7/64	2,78
1/4	6,35	7/32	5,55	5/32	3,97	1/8	3,17
5/16	7,94	1/4	6,35	3/16	4,75	9/64	3,57
5/16	7,94					5/32	3,97
3/8	9,52	5/16	7,94	7/32	5,55	3/16	4,75
7/16	11,11	3/8	9,52	1/4	6,35	7/32	5,55
1/2	12,7	3/8	9,52	5/16	7,94	1/4	6,35
5/8	15,87	1/2	12,7	3/8	9,52	5/16	7,94
3/4	19,05	5/8	15,88	1/2	12,7	3/8	9,52
7/8	22,2	3/4	19,05	9/16	14,29	1/2	12,7
1	25,4	3/4	19,05	5/8	15,88	9/16	14,29
1"1/8	28,57	7/8	22,2	3/4	19,05	9/16	14,29
1"1/4	31,75	7/8	22,2	7/8	22,2	5/8	15,88
1"3/8	34,92	1"	25,4	7/8	22,2	5/8	15,88
1"1/2	38,10	1"	25,4	1"	25,4	3/4	19,05

TORX® HEADS

Relationship NF EN ISO 10664 screw diameter / TORX® key

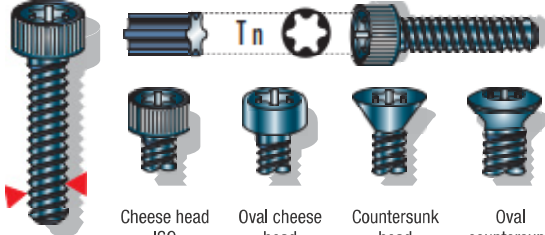

Ø Screw mm	Cheese head ISO 14579/14580	Oval cheese head ISO 14584	Countersunk head NF E 25-107	Oval countersunk head ISO 14583
M2,0	T6	T6	T6	T6
M2,5	T8	T8	T8	T8
M3,0	T10	T10	T10	T10
M3,5	T15 (1)	T15	T10	T15
M4,0	T20	T20	T20	T20
M5,0	T25	T25	T20	T25
M6,0	T30	T30	T30	T30
M8,0	T45	T45	T40	T45
M10,0	T50 (1)	T50	T50	T50
M12,0			T55	

(1) ISO 14580

Key pattern identification



T N°	mm
T6	1,65
T8	2,30
T10	2,72
T15	3,26
T20	3,84
T25	4,40
T27	4,96
T30	5,49
T40	6,60
T45	7,77
T50	8,79
T55	11,22

Relationship screw diameter / TORX® socket

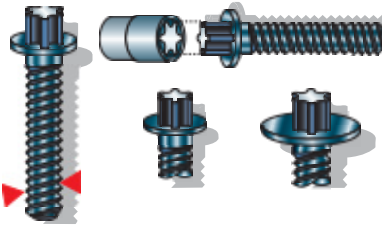

Ø Screw mm	Wide collar	
M3	E4	
M4	E5	E6
M5	E6	E8
M6	E8	E10
M8	E10	E12
M10	E12	E14
M12	E14	E18
M14	E18	E20
M16	E20	

SLOTTED HEADS



Relationship screw diameter/slot size

Engineering screws

Screw mm	Countersunk head NF EN ISO 2009		Oval countersunk head NF EN ISO 2010		Cheese head NF EN ISO 1207		Widecheese head NF EN ISO 1580	
	Ø	e x A	Ø	e x A	Ø	e x A	Ø	e x A
M1,6	0,4	x 2,5	0,4	x 2,5	0,4	x 2,5	0,4	x 2,5
M2	0,5	x 3	0,5	x 3	0,5	x 3	0,5	x 3
M2,5	0,6	x 3,5	0,6	x 3,5	0,6	x 3,5	0,6	x 3,5
M3	0,8	x 4	0,8	x 4	0,8	x 4	0,8	x 4
M3,5	1,0	x 5,5	1,0	x 5,5	1,0	x 5,5	1,0	x 5,5
M4	1,2	x 6,5	1,2	x 6,5	1,2	x 6,5	1,2	x 6,5
M5	1,2	x 8	1,2	x 8	1,2	x 8	1,2	x 8
M6	1,6	x 10	1,6	x 10	1,6	x 8	1,6	x 10
M8	2,0	x 12	2,0	x 12	2,0	x 12	2,0	x 12
M10	2,5	x 14	2,5	x 14	2,5	x 14	2,5	x 14

Self-tapping screws

Screw mm	Countersunk head NF EN ISO 1482		Oval countersunk head NF EN ISO 1483		Wide cheese head NF EN ISO 1481	
	Ø	e x A	Ø	e x A	Ø	e x A
ST,2,2	0,5	x 3	0,5	x 3	0,5	x 3
ST,2,9	0,8	x 4	0,8	x 4	0,8	x 4
ST,3,5	1	x 5,5	1	x 5,5	1	x 5,5
ST,4,2	1,2	x 6,5	1,2	x 6,5	1,2	x 6,5
ST,4,8	1,2	x 8	1,2	x 8	1,2	x 8
ST,5,5	1,6	x 8	1,6	x 8	1,6	x 10
ST,6,3	1,6	x 10	1,6	x 10	1,6	x 10
ST,8	2	x 12	2	x 12	2	x 1,2
ST,9,5	2,5	x 14	2,5	x 14	2,5	x 14

Wood screws

Screw mm	Countersunk head NF E 25-604		Oval countersunk head NF E 25-605		Round head NF E 25-606	
	Ø	e x A	Ø	e x A	Ø	e x A
1,6	0,4	x 2,5			0,4	x 2
2	0,5	x 3	0,5	x 3	0,5	x 3
2,5	0,6	x 3,5	0,6	x 3,5	0,6	x 3,5
3	0,8	x 4	0,8	x 4	0,8	x 4
3,5	1,0	x 5,5	1,0	x 5,5	1,0	x 5,5
4	1,2	x 6,5	1,2	x 6,5	1,2	x 6,5
4,5	1,2	x 8	1,2	x 8	1,2	x 6,5
5	1,2	x 8	1,2	x 8	1,2	x 8
6	1,6	x 10	1,6	x 10	1,6	x 10
7	2,0	x 12			2,0	x 10
8	2,0	x 12			2,0	x 12



PROTWIST

➔ 418



HEXAGON KEYS

➔ 444



BITS

➔ 197

PHILLIPS® AND POZIDRIV® HEADS



Relationship screw diameter/pattern size

Engineering screws

Screw mm	Countersunk head ISO 7046		Oval countersunk head ISO 7047		Oval cheese head ISO 7045		Wide oval cheese head NFE 25-122	
	Ø	Nbr.	Ø	Nbr.	Ø	Nbr.	Ø	Nbr.
M 1,6	0	0	0	0				
M 2,0	0	0	0	0				
M 2,5	1	1	1	1				
M 3,0	1	1	1	1	1	1		
M 3,5	2	2	2	2	2	2		
M 4,0	2	2	2	2	2	2		
M 5,0	2	2	2	2	2	2		
M 6,0	3	3	3	3	3	3		
M 8,0	4	4	4	4	4	4		
M 10,0	4	4	4	4				

Self-tapping screws

Screw mm	Countersunk head ISO 7050		Oval countersunk head ISO 7051		Cheese head ISO 7049		Wide oval cheese head NF E 25-659	
	Ø	Nbr.	Ø	Nbr.	Ø	Nbr.	Ø	Nbr.
ST,2,2	0	0	0	0				
ST,2,9	1	1	1	1	1	1		
ST,3,5	2	2	2	2	2	2		
ST,4,2	2	2	2	2	2	2		
ST,4,8	2	2	2	2	2	2		
ST,5,5	3	3	3	3	3	3		
ST,6,3	3	3	3	3	3	3		
ST,8	4	4	4	4				
ST,9,5	4	4	4	4				

Wood screws

Screw mm	Countersunk head NF E 25-601		Oval countersunk head NF E 25-602		Round head NF E 25-603	
	Ø	Nbr.	Ø	Nbr.	Ø	Nbr.
2,5	1	1	1	1		
3	1	1	1	1		
3,5	2	2	2	2		
4	2	2	2	2		
4,5	2	2	2	2		
5	2	2	2	2		
6	3	3	3	3		



FACOM GUARANTEE



**FACOM GUARANTEES
ITS PRODUCTS
AGAINST FAULTY MATERIALS
OR WORKMANSHIP
UNDER THE CONDITIONS
DEFINED BELOW.**



The FACOM Guarantee is fully part of the brand's commitments towards its clients. It ensures total satisfaction with FACOM products.

Over the last 60 years, FACOM guarantees the quality of its products, by means of free replacement or repair guarantee of its products without any time limit (excluding technical products, torque tools, roller cabinets and furniture).

The **FACOM Guarantee** is applicable by all FACOM dealers.

FACOM has implemented a specific organisation to manage and follow up returned products, for unequalled responsiveness to client requests:

- Returned products are first managed by the distributor network, entrusted with applying the **FACOM Guarantee** and replacing items on stock (under reservation of availability).
- Daily processing of returns within FACOM, by an 18-person department dedicated to applying the warranty.



IMPLEMENTATION OF THE GUARANTEE

- The FACOM guarantee takes the form of an exchange or repair limited to replacement of the faulty parts in accordance with the terms and conditions specified below.
- The faulty product must be returned to the Facom distributor, failing which repair under guarantee may be refused.
- This guarantee includes the parts and the labour provided by the Facom after sales service or the approved distributor.
- All repairs are guaranteed six months parts and labour. This guarantee only applies to the components changed during the previous repair, with the exception of consumables.
- In line with its policy of continual product improvements to meet user needs and technological developments, Facom may upgrade or discontinue the models shown in its catalogue without notice and without entailing any obligation on

its part to repair tools or equipment sold previously. Those items no longer included in the range will then be replaced by a technically equivalent product or a credit note will be issued.

CONDITIONS OF APPLICATION OF THE FACOM GUARANTEE

UNLESS OTHERWISE SPECIFIED, THE FACOM GUARANTEE APPLIES TO ALL TOOLS UNDER NORMAL CONDITIONS OF USE.

The guarantee excludes the following :

Consumables (i.e. products that become deteriorated or damaged during use). These include, but are not limited to, drill bits, saw blades, abrasive discs, knife blades, files, batteries, driving bits, etc.

Normal wear and tear (in particular of wearing parts), failure to use the product for its intended purpose or in accordance with our instructions, neglect or inadequate maintenance on the part of the user.

Defective operation due to modifications or repairs not carried out by Facom's after sales service or that of its approved distributors, Defective operation due to causes external to the pro-

duct (theft, dropping, lightning, flooding, fire, damage during transport, product not returned in its original packaging, etc.).

- The guarantee period takes effect from the date of purchase by the customer from the Facom customer-distributor. A copy of the invoice proving the date of purchase from the distributor may be requested in the event of a claim under the guarantee. In the case of technical products covered by a limited guarantee type D, it shall systematically be supplied by the user customer together with the serial number where one is indicated on the tool.
- The guarantee will apply for the period indicated in the price list applying on the date of purchase.

- Where the product is no longer covered by the guarantee (expiry of the guarantee period, guarantee inapplicable for the reasons given in paragraph 2) yet is repairable, this repair will be carried out only after acceptance by the user of the repair estimate.
- The application of the guarantee will not give risk to any kind of indemnity or damages for any reason whatsoever.

TYPES OF GUARANTEE (PRICE LIST COLUMN G)

GUARANTEE TYPE E : the tool will be exchanged free of charge, in accordance with the conditions of implementation and application of the guarantee (cf. paragraphs 1 and 2 above) and without limit of time.

GUARANTEE TYPE R : the tool will be repaired or replaced with a repaired tool in a similar condition in accordance with the conditions of implementation and application of the guarantee (cf. paragraphs 1 and 2 above) and without limit of time.

GUARANTEE TYPE D : this guarantee is subject to a time limit. The guarantee period is specified by a figure after

the D. It applies mainly to technical products or machines. In accordance with the conditions of implementation and application of the guarantee (in particular the exclusion of wearing parts - cf. paragraphs 1 and 2 above), this guarantee covers the repair and replacement of defective parts, free of charge, during the period of validity.

- In the event that Facom is no longer able to exchange a product under guarantee with another having the same reference, it undertakes to provide a technically equivalent product or to issue a credit note if no corresponding product is available.

- The type of guarantee applying to a product can be determined simply by referring to the current price list (column G) available at any Facom distributor. For certain product references, the type of guarantee is indicated on the packaging or in the accompanying documentation.
- Those items for which no guarantee type is specified (column G empty), are covered only by the statutory guarantee.
- Each item of a set continues to be covered by its own guarantee jurisdiction. Applicable legislation.

JURISDICTION. APPLICABLE LEGISLATION

IN THE EVENT OF PROBLEMS CONCERNING THE APPLICATION HEREOF, THE USER CAN CONTACT:

In France :

– Facom Customer Services, 6 and 8 rue Gustave Eiffel, 91420 Morangis.

Outside France:

– The Facom subsidiaries listed on page 868 of the Catalogue and on the Facom Web site www.facom.fr

– Facom distributors

- Any dispute in relation to the interpretation or execution hereof that cannot be amicably resolved between the parties will be subject to French law and the sole jurisdiction of the Paris Courts.

TERRITORIAL EXTENT

The FACOM contractual guarantee applies in all countries in which the product is officially sold and distributed.

STATUTORY GUARANTEE

Irrespective of the FACOM contractual guarantee, the user is also covered by the provisions of articles 1641 to 1649 of the French Civil Code relating to hidden defects.

'Auto electricians' kit	1074	1/2" fast ratchet with rotating handle	326	1/4" drive tee with universal joint	288
'C-clamp' arc-welding lock-grip pliers	515	1/2" female Torx® impact sockets	354	1/4" drive tee with universal joint	288
'Connector' pliers	519	1/2" Hi-Lok® ratchet - FLUO	819	1/4" electrical ratchet 10.8V 2.0Ah	715
'Connector' pliers - FLUO	841	1/2" Hi-Lok® ratchet - Fluo	918	1/4" fast ratchet with rotating handle	282
'Contact' file	1060	1/2" impact bit holder sockets	356	1/4" fast ratchet with rotating handle - FLUO	813
'Extra-wide capacity' straight-jaw pliers	503	1/2" impact screwdriver	481	1/4" fast ratchet with rotating handle - RFID	860
'Heavy-duty' offset ring wrenches	236	1/2" impact socket for Mercedes wheel nuts	1127	1/4" high performance sealed locking ratchet	282
'Heavy-duty' offset ring wrenches - SLS	783	1/2" impact sockets for wheel nuts	1126	1/4" high performance sealed locking ratchet - FLUO	813
'HGV, bus' wheel lift	1024	1/2" interchangeable male drive	344	1/4" high performance sealed locking ratchet - RFID	860
'HGV, bus' wheel lift	1171	1/2" locking extensions	330	1/4" high performance sealed ratchet	282
'LCV' trolley jacks	1023	1/2" locking extensions - RFID	871	1/4" high performance sealed ratchet - SLS	785
'Long-reach' lock-grip pliers	516	1/2" long-reach impact sockets for wheel nuts	1126	1/4" lock-ring bit holder - FLUO	828
'Low torque' click torque wrenches	376	1/2" long-reach ratchet	327	1/4" locking extension	287
'Low torque' click torque wrenches - RFID	876	1/2" offset ratchet	328	1/4" locking extension - RFID	861
'Micromécanique' open-end wrenches	226	1/2" original ratchet	327	1/4" locking extensions - FLUO	814
'Micromécanique' open-end wrenches - FLUO	810	1/2" reinforced impact socket set	1127	1/4" long-reach sockets Spline	912
'Multi-model' press protection	1032	1/2" screwdriver long-reach and extra long-reach sockets for 6-point countersunk head screws	335	1/4" metric 6-point socket and bit set	281
'No vernier' adjustable angle torque wrenches	387	1/2" screwdriver sockets for countersunk hex head screws	334	1/4" mini ratchet	692
'No vernier' adjustable click torque wrenches	387	1/2" screwdriver sockets for countersunk hex head screws	355	1/4" original ratchet	283
'Refrigeration' flaring tool	730	1/2" sockets for 16, 18 and 21 mm spark plugs	1057	1/4" reversible gun screwdriver	694
'Refrigeration' kit	730	1/2" Titanium pneumatic ratchet	691	1/4" reversible screwdriver	694
'Screw jaw' lock-grip pliers	516	1/2" to 3/4" coupler	331	1/4" screwdriver handle	285
'Screw sliding jaw' lock-grip pliers	516	1/2" to 3/4" impact coupler	356	1/4" screwdriver sockets for hex head screws	294
'Two-hands' orbital sander 150 mm - 10 mm orbit	696	1/2" to 3/8" coupler	331	1/4" secure spring-clip bit holder - FLUO	815
'Two-hands' orbital sander 150 mm - 5 mm orbit	696	1/2" to 3/8" coupler - RFID	872	1/4" sockets Spline	912
'Junior' model multiblade screwdrivers	440	1/2" to 3/8" impact coupler	356	1/4" standard extension	286
'Pocket' bit holder handle	463	1/2" to CDX® coupler	331	1/4" standard extension - RFID	861
'Production' torque screwdrivers	395	1/2" Torx® bit impact screwdriver sockets	355	1/4" Standard ratchet	693
'Radio' model multiblade screwdrivers	440	1/2" Torx® bit impact screwdriver sockets	355	1/4" to 3/8" coupler	288
'Standard' model multiblade screwdrivers	440	1/2" Torx® impact screwdriver sockets	354	1/4" to 3/8" coupler - FLUO	815
'11-in-1" flat set	216	1/2" Torx® impact sockets	354	1/4" to 3/8" coupler - RFID	862
1 t europalette workshop crane	1028	1/2" Torx® screwdriver sockets	335	1/4" Torx® screwdriver sockets	294
1 t workshop crane	1027	1/2" Torx® sockets	334	1/4" Torx® sockets	293
1" 1/2 impact extension	363	1/2" universal joint	330	1/4" ultra compact ratchet for 1/4" end bits	284
1" 1/2 impact universal joint	363	1/2" universal joint - RFID	872	1/4" ultra compact 180° flexible head ratchet for 1/4" end bits	283
1" 1/2 to 1" impact coupler	363	1/2" VSE series 1000 Volt insulated 12-point long-reach sockets	966	1/4" ultra compact 180° flexible head ratchet for HX series 1/4" sockets	284
1" 1/2 to 2" 1/2 impact coupler	363	1/2" VSE series 1000 Volt insulated 12-point sockets	966	1/4" universal joint	288
1" 12-point impact socket	362	1/2" VSE series 1000 Volt insulated extensions	968	1/4" universal joint - RFID	861
1" 12-point sockets - ADF	749	1/2" VSE series 1000 Volt insulated handle	967	1/4" VSE series 1000 Volt insulated 6-point sockets	963
1" 12-point sockets 65 mm	1179	1/2" VSE series 1000 Volt insulated male 6-point sockets	967	1/4" VSE series 1000 Volt insulated extension	964
1" 6-point extra-long impact sockets	362	1/2" XZN® impact screwdriver sockets	355	1/4" VSE series 1000 Volt insulated ratchet	963
1" 6-point impact sockets	361	1/2" XZN® long-reach impact screwdriver sockets	355	1/4" wobble extension	287
1" 6-point long-reach impact sockets	361	1/2" XZN® screwdriver socket set	336	10 t hydraulic jack for U.312H	639
1" 6-point long-reach thin wall impact sockets	362	1/2" - 3/4" - 1" ratchets - ADF	746	10 t hydraulic screw	639
1" drive 12-point sockets	348	1/2" - 3/4" - 1" sliding handles - ADF	747	10-piece case of 18 mm snap-off blades	618
1" drive 6-point sockets	348	1/2" - 3/4" - 1" universal joints - ADF	747	10-piece case of 9 mm snap-off blades	618
1" drive impact extensions	362	1/2" - 3/4" - 1" extension - ADF	747	10-piece set of 1/4" inch 12-point long-reach sockets set on rack - FLUO	816
1" drive impact universal joint	362	1/4 Hi-Lok® ratchet - FLUO	812	10-piece set of 1/4" bits 50 mm long with groove - series 1	465
1" drive ratchet without handle	346	1/4 Hi-Lok® ratchet - Fluo	918	10-piece set of 1/4" bits 50 mm long-reach - series 1	465
1" drive sliding tee	347	1/4" - 5/16" bit holder ratchet	284	10-piece set of 1000 Volt insulated tools	970
1" extensions	347	1/4" - 5/16" bit holder ratchet - FLUO	814	10-piece set of metric ratchet open end combination wrenches	207
1" to 1 1/2" impact coupler	363	1/4" - 5/16" bit holder ratchet - RFID	861	10-piece set of Micro-Tech® short-race combination wrenches	999
1" to 3/4" coupler	347	1/4" 'no handle' ratchet	284	10.8V pack - 1/2" compact impact wrench + Drill/Bolter 10 mm 2Ah	716
1 1/2 6-point impact sockets	363	1/4" 'Palm control' ratchet	693	1000 Volt insulated combination pliers - RFID	893
1/2" 12-point impact sockets	353	1/4" 12-point hinged sockets	293	1000 Volt insulated electricians diagonal cutters - RFID	892
1/2" 12-point long-reach impact sockets	354	1/4" 12-point hinged sockets - RFID	865	1000 Volt insulated flat nose pliers - RFID	893
1/2" 12-point long-reach sockets	333	1/4" 12-point long-reach sockets	292	1000 Volt insulated half-round long nose pliers - RFID	892
1/2" 12-point long-reach sockets - RFID	875	1/4" 12-point long-reach sockets - FLUO	817	1000 Volt insulated half-round short nose pliers - RFID	893
1/2" 12-point sockets	332	1/4" 12-point long-reach sockets - RFID	864	1000 Volt insulated strippers - RFID	893
1/2" 12-point sockets - ADF	748	1/4" 12-point sockets	291	1000 Volt multitrip pliers - RFID	892
1/2" 12-point sockets - RFID	874	1/4" 12-point sockets	291	11-piece set of Micro-Tech® tools	999
1/2" 6-point impact sockets	352	1/4" 12-point sockets - FLUO	816	12 - 24 Volt surge limiter	1070
1/2" 6-point long-reach impact sockets	353	1/4" 12-point sockets - RFID	863	12-piece set of contact cleaning diamond needle files	1073
1/2" 6-point long-reach sockets	333	1/4" 12-point sockets - RFID	863	120 t mechanical screw jack	640
1/2" 6-point long-reach sockets - RFID	873	1/4" 12-point thin wall sockets	291	12V - 24V starting booster	1067
1/2" 6-point long-reach thin-wall impact sockets	353	1/4" 6-point hexagonal sockets	290	135-piece bodywork tool set	1151
1/2" 6-point sockets	332	1/4" 6-point long-reach sockets	291	136-piece set of inch fluorescent tools	808
1/2" 6-point sockets - RFID	873	1/4" 6-point long-reach sockets - RFID	865	14 x18 mm open end bit set	406
1/2" angular extensions	330	1/4" 6-point sockets	290	14 x18 mm polygon bit set	407
1/2" battery impact wrenches	712	1/4" 6-point sockets - FLUO	815	143-piece set of metric fluorescent tools	807
1/2" bit holder socket	331	1/4" 6-point sockets - FLUO	816	15 t hydraulic bench press	1030
1/2" bit holder sockets with retaining clip	331	1/4" 6-point sockets - RFID	862	15-piece set of forming tools: the essential for professionals	1152
1/2" drive hinged handle - 381 mm	328	1/4" and 1/2" sockets and Torx® screwdriver bit set	1136	15° angled offset-ring ratchets	212
1/2" drive impact bits set	479	1/4" angular extension	287	15° angled offset-ring ratchets - FLUO	810
1/2" drive impact extensions	356	1/4" bit holder socket	289	15° angled offset-ring ratchets - RFID	857
1/2" drive impact universal joint	356	1/4" bit set	281	16-piece set of Micro-Tech® tools	999
1/2" drive long-reach Torx® bit sockets	335	1/4" crowfoot open end bit set	408	18-piece set of partitions for drawers 50 and 75 mm high	123
1/2" drive long-reach XZN® spline bit sockets	335	1/4" Crowfoot open end bit set	916	18V pack - 1/2" high performance impact wrench + Drill/Bolter 13 mm 5Ah	716
1/2" drive metal-grip hinged extending handle	328	1/4" crowfoot open end bits	404	19-piece set of 1000 Volt insulated tools	971
1/2" drive metal-grip hinged handle - 410 mm	328	1/4" drive flexible spinner	286	2-piece set of extra-long reach double jointed pliers	518
1/2" drive offset adaptor	331	1/4" drive hinged handle - 150 mm	285	2-piece set of multiple opening metric straight ratchet ring wrenches	215
1/2" drive sliding tee	328	1/4" drive long spinner	286	2-piece set of nut splitters	862
1/2" drive speed brace	329	1/4" drive long spinner - FLUO	815	2-piece set of reversible pliers	508
1/2" drive tee with universal joint	329	1/4" drive medium spinner - FLUO	814	2-piece set of sanding wedges	1159
1/2" drive XZN® spline bit sockets	335	1/4" drive short spinner	286	2-piece set of self-adjusting sanding wedges	1158
1/2" extension - RFID	872	1/4" drive short spinner - FLUO	814	2-piece set of tuning screwdrivers for slotted head screws	1008
1/2" extensions	329	1/4" drive sliding tee	285	2-piece sets of bits	648
1/2" extra-long drive tee with universal joint	329	1/4" drive speed brace	286	2-piece sets of spare pins	254

ALPHABETIC INDEX

2-set of caps for HGV / LUV.....	1055	3/8" 6-point long-reach sockets	309	4-piece set of spatulas1098
2-speed hydraulic hand pump	639	3/8" 6-point long-reach sockets - RFID.....	869	4-piece set of straight Torx® ring wrenches.....
20 t and 30 t hollow jacks for U.320H and U.330H.....	639	3/8" 6-point magnetic oil-drain sockets.....	1045	4-Ton kit.....
20 t hydraulic press.....	1030	3/8" 6-point sockets	308	41-piece set of 1000 Volt insulated tools
20-piece car radio removing tool kit.....	1074	3/8" 6-point sockets - RFID	869	5-piece set of "T" spinner hexagon keys
20-piece set of forming tools: the indispensable for specialists.....	1152	3/8" angular extensions.....	306	5-piece set of 3-in-1 PROTWIST® screwdrivers.....
20-piece set of short-reach cylinder head bits	1092	3/8" bit holder impact sockets	352	5-piece set of belt-tensioner nut wrenches.....
21-piece set of 1/4" and 1/2" Torx® sockets and bits.....	334	3/8" bit holder socket with locking ring for 1/4" squares.....	307	5-piece set of clockwork screwdrivers for slotted head screws.....
21-piece set of 1/4" and 1/2" Torx® sockets and bits.....	294	3/8" bit holder sockets with retaining clip.....	307	5-piece set of drive bits for spline socket head (XZN) bits 1/2".....
26-piece sets of letter punches and punch	549	3/8" crowfoot 12-point end bits	404	5-piece set of forming tools: the indispensables.....
27-piece set of partitions for drawers 75 mm high.....	123	3/8" crowfoot 12-point spline end bits.....	404	5-piece set of long shank Torx® screwdriver
3-in-1 PROTWIST® screwdriver set.....	441	3/8" crowfoot box end bits	406	5-piece set of metric flare-nut wrench angled at 15°.....
3-piece CPE plier set	520	3/8" Crowfoot open end bit set	917	5-piece set of metric half-moon ring wrenches.....
3-piece set of 'mechanical' pliers	521	3/8" crowfoot open end bits	405	50 t hydraulic screw
3-piece set of 1000 Volt pliers	521	3/8" drain plug bit with male triangle.....	1047	57-piece set of plastic boxes
3-piece set of contact cleaning diamond tweezers.....	1073	3/8" drive hinged handle - 260 mm.....	304	6-piece set of 15° angled offset-ring ratchets
3-piece set of couplers.....	289	3/8" drive impact bits set	479	6-piece set of bodywork vice pliers.....
3-piece set of couplers.....	307	3/8" drive impact extensions.....	351	6-piece set of clockwork screwdrivers for hex Phillips® head screws.....
3-piece set of couplers.....	331	3/8" drive impact universal joint.....	351	6-piece set of fluorescent PROTWIST® screwdrivers + 1 12-LED UV lamp - FLUO.....
3-piece set of flexible stainless steel spatulas.....	607	3/8" drive metal-grip hinged handle - 255 mm.....	304	6-piece set of keys for 6-point safety screws.....
3-piece set of High Perf® bits for Phillips® screws.....	467	3/8" drive sliding tee	304	6-piece set of PROTWIST® stainless steel screwdrivers.....
3-piece set of High Perf® bits for Pozidriv® screws.....	467	3/8" drive speed brace	304	6-piece set of suction cups.....
3-piece set of High Perf® bits for slotted head screws.....	467	3/8" drive tee with universal joint	305	6-piece set of T-handle wrenches with sliding bar
3-piece set of plastic boxes	191	3/8" electrical ratchet 10.8V 2.0Ah	715	63-piece set of bits - FLUO
3-piece set of plastic nozzles.....	1146	3/8" extension - RFID	866	7-piece set of 6-diplin bits 1/2".....
3-piece set of power levers.....	722	3/8" extensions	305	7-piece set of metric ratchet open end combination wrenches
3-piece set of screw bits series 1 for metric countersunk hex head screws.....	462	3/8" fast ratchet with rotating handle	302	7-piece set of short drill bits for straight chucks
3-piece set of series 1 Torx® bits T20-25-30.....	461	3/8" Hi-Lok® ratchet - FluO.....	817	75° plastics cutters.....
3-piece set of series 1 Torx® bits T8-10-15.....	461	3/8" Hi-Lok® ratchet - FluO.....	918	8-piece set of angled keys in pocket - FLUO.....
3-piece set of socket wrenches	217	3/8" high performance sealed locking ratchet.....	302	8-piece set of partitions for drawers 125 mm high.....
3-piece set of stainless steel scrapers	607	3/8" high performance sealed locking ratchet - FLUO.....	818	8-piece set of pushers 10 to 30 mm
3-piece sets of bits for Phillips® screws - High Perf® - series 6.....	473	3/8" high performance sealed locking ratchet - RFID.....	866	9 x12 mm open end bit set
3-piece sets of bits for Pozidriv® screws - High Perf® - series 6.....	473	3/8" high performance sealed locking ratchet - SLS.....	785	9 x12 mm polygon bit set
3-piece sets of High Perf® bits series 1	467	3/8" high performance sealed ratchet.....	302	9-piece set of adapters for ratchet ring wrenches 464.M14X19
3-piece sets of High Perf® Titanium bits series 1	468	3/8" high performance sealed ratchet.....	303	9-piece set of angled keys in pocket - FLUO.....
3-piece sets of High Perf® titanium bits series 6	473	3/8" high performance sealed ratchet with locking extending handle.....	303	9-piece set of clockwork screwdrivers for slotted head screws.....
3-piece sets of screw bits series 1 for metric countersunk hex head screws.....	462	3/8" impact screwdriver	480	9-piece set of hexagonal stainless steel keys.....
3-piece sets of screw bits series 6 for countersunk hex head screws	471	3/8" impact socket Spline 14 (7/16").....	913	9-piece sets of bits and 6 drainage sockets
3-piece sets of standard bits - series 6 for Torx® screws.....	472	3/8" locking extensions	306	9-piece sets of digit punches.....
3-piece sets of standard bits for slotted head screws - series 6	472	3/8" locking extensions - RFID	866	9-piece sets of High Perf® bits
3-piece sets of standard Torx® bits series 1	461	3/8" long-reach drive tee with universal joint.....	305	
3/4" socket set	1178	3/8" long-reach sockets Spline.....	913	■ A
3/4" 12-point impact sockets	358	3/8" magnetic oil-drain key	1046	ABS body tape measure - 3 metres - RFID.....
3/4" 12-point long-reach impact sockets	359	3/8" magnetic oil-drain male hex bits.....	1046	ABS body tape measure - mm and inches
3/4" 12-point metric sockets - ADF	749	3/8" Mini pneumatic ratchet.....	692	ABS body tape measures
3/4" 12-point sockets	345	3/8" offset ratchet	305	ABS body tape measures - SLS
3/4" 6-point impact sockets	358	3/8" oil-drain female square bit 10 mm.....	1046	Accessories for punches and callipers
3/4" 6-point long-reach impact sockets	358	3/8" original ratchet.....	303	Acid hydrometer
3/4" 6-point long-reach sockets	346	3/8" piping bit set	917	Adaptable magnet for slim lamp.....
3/4" 6-point long-reach thin wall impact sockets	359	3/8" piping crowfoot open end bit set	409	Adapter bit for pliers U.49P5 to P9 on slide hammer or jib
3/4" 6-point sockets	345	3/8" screwdriver sockets for countersunk hex head screws	311	Adapter bits for U.301 / U.302 pullers on slide hammer U.49AM
3/4" drive 'Site' ratchet.....	342	3/8" sockets for 14 mm bi-hexagonal spark plugs	1057	Additional and spare tips for pliers 477 to 499
3/4" drive fixed adaptor.....	343	3/8" sockets for 16, 18 and 21 mm spark plugs	1057	Additional shelf.....
3/4" drive hinged handle	343	3/8" sockets Spline	913	Additional shelf.....
3/4" drive impact extensions	360	3/8" square drive hinged wrenches for glow plugs	1061	ADF saw blade.....
3/4" drive impact universal joint	360	3/8" Standard ratchet.....	693	ADF wedges
3/4" drive ratchet with removable handle	341	3/8" Titanium pneumatic ratchet	692	Adjustable tap wrench
3/4" drive ratchet without handle.....	342	3/8" to 1/2" coupler.....	307	Adjustable wrenches.....
3/4" drive sliding tee	343	3/8" to 1/2" coupler - RFID.....	867	Adjustable wrenches - ADF.....
3/4" extensions	344	3/8" to 1/2" impact coupler.....	351	Adjustable wrenches - FLUO.....
3/4" hexagonal socket 43 mm "PL-IVECO".....	1179	3/8" to 1/4" coupler.....	307	Adjustable wrenches - RFID.....
3/4" high performance sealed ratchet.....	341	3/8" to 1/4" coupler - RFID.....	867	Adjustable wrenches - SLS.....
3/4" impact screwdriver sockets for countersunk hex head screws	359	3/8" Torx® magnetic oil-drain key.....	1046	Air hammer
3/4" impact socket set	357	3/8" Torx® screwdriver sockets.....	311	Air impact wrenches.....
3/4" interchangeable male drive.....	347	3/8" Torx® sockets.....	311	Air needle rust remover
3/4" long-reach Torx® impact sockets.....	359	3/8" universal joint	306	Air scriber pen.....
3/4" screwdriver sockets for countersunk hex head screws	359	3/8" universal joint - RFID.....	867	Air-hose reel.....
3/4" socket for angular tightening of the hub nut.....	1129	3/8" VSE series 1000 Volt insulated 12-point long-reach sockets.....	964	Air-line connector and gauge
3/4" Tamper Torx® impact sockets.....	360	3/8" VSE series 1000 Volt insulated 12-point sockets	964	Air-operated valve grinder.....
3/4" to 1" coupler.....	344	3/8" VSE series 1000 Volt insulated extensions.....	966	Aluminium brake bleeder plug
3/4" to 1" impact coupler	361	3/8" VSE series 1000 Volt insulated handle.....	965	Aluminium rivet maintenance set
3/4" to 1/2" coupler.....	344	3/8" VSE series 1000 Volt insulated male 6-point sockets.....	965	Aluminium trolley jacks
3/4" to 1/2" impact coupler	360	3/8" wobble extension	306	Analog brake bleeders
3/4" universal joint	344	30 t hydraulic press	1031	Angle grinder with 6 mm collet
3/4" XZN® impact sockets.....	360	30 t mechanical screw jack	640	Angle sander diameter 178 mm.....
3/8 crowfoot open end bit set	408	32-piece set of 1000 Volt insulated tools	972	Angle sander diameter 178 mm.....
3/8" 'Palm control' ratchet.....	693	36-piece set of plastic boxes	124	Angled box wrenches
3/8" 12-point hinged sockets	311	37-piece set of 1/4" metric hexagon keys and bits	290	Angled composite pneumatic grinder 125 mm.....
3/8" 12-point hinged sockets - RFID.....	871	3M tape measure with grip body.....	550	Angled open-socket wrenches
3/8" 12-point long-reach sockets	310	4-piece set of 'mechanical' pliers	521	Angled open-socket wrenches - RFID
3/8" 12-point long-reach sockets - FLUO.....	819	4-piece set of 90° cone bits	806	Angled open-socket wrenches - SLS
3/8" 12-point long-reach sockets - RFID.....	870	4-piece set of Circlip® pliers	506	Angled pneumatic grinder 0.3 HP 120° with 6 mm collet.....
3/8" 12-point sockets.....	308	4-piece set of CPE pliers.....	520	Angled pneumatic grinder 0.5 HP 90° with 6 mm collet.....
3/8" 12-point sockets - FLUO	818	4-piece set of hooks	1097	Angled pneumatic grinder 125 mm.....
3/8" 12-point sockets - RFID	868	4-piece set of nipples.....	710	Angled pneumatic grinder 50 mm - 2".....
3/8" 12-point spline socket set.....	409	4-piece set of plastic multi-use scrapers	1137	Angled pneumatic grinder diam. 100 mm
3/8" 12-point thin wall sockets.....	309	4-piece set of pliers - FLUO	833	Angled pneumatic grinder with 90° angle 0.3 HP with 6 mm collet.....
3/8" 6-point impact sockets	351	4-piece set of socket wrenches	217	

Angled screwdrivers - for Phillips® screws.....	444
Angled screwdrivers for slotted head screw.....	444
Angled socket wrenches - ADF.....	744
Angled, flat short double spoon.....	1150
Angular tightening wrenches.....	1095
Angular tightening wrenches.....	1180
Angular tightening wrenches.....	410
Angular torque coupler.....	391
Angular wrenches 1/2" drive bit.....	1094
Anti-freeze hydrometer.....	1087
Anti-theft bar for roller cabinets.....	83
Antistatic 68-watt digital soldering station.....	1013
Antistatic tweezers.....	1004
Arc-welding lock-grip pliers.....	515
Arc-welding press.....	737
Automatic centre punch.....	577
Automatic lateral wire strippers.....	930
Automatic multiprip pliers.....	503
Automatic oil-filter cap.....	1054
Automatic plastic cable-tie pliers.....	940
Automatic pliers for clamps.....	1085
Automatic screwdriver with hex 1/4" bit holder.....	442
Automatic wire cutters-strippers.....	930
Automotive multimeter.....	1062
Automotive voltage tester.....	1064
Axial steering ball joint puller.....	1130
B	
Backup unit OBD.....	1070
Bag fitted with 2 retractable lanyards - SLS.....	773
Bag for carrying spare parts - SLS.....	773
Bag of 3 HOOK holders - SLS.....	769
Ball head mechanics hammers.....	564
Ball joint puller.....	1187
Ball joint pullers.....	1129
Bar for 3/4" ratchet.....	343
Bars for 1" ratchet M.151.....	347
Bars for wrenches 91A - 92A - 97.....	244
Basic flanged squares - Class I.....	544
Basic flanged squares - Class II.....	544
Basic squares - Class I.....	543
Basic squares - Class II.....	544
Battery chargers for vehicles.....	1066
Battery filler.....	1071
Battery terminals puller.....	1071
Battery tester with printer.....	1072
Beam for U.28 and U.51B pullers.....	649
Beam for U.51B and U.306 pullers.....	649
Beams for jacks.....	655
Bearing bit puller set.....	647
Belt sander - 10 x 330 mm.....	1156
Belt sander - 10 x 330 mm.....	699
Belt with double point metal buckle - SLS.....	772
Bending clamps.....	726
Bi-material toolbox.....	186
Bit holder impact sockets.....	477
Bit holder impact sockets.....	479
Black roller cabinet.....	181
Blind nut pliers.....	733
Blind nut set.....	731
Blocking tray for roller cabinet drawers.....	86
Blocks - drawers.....	120
Bluetooth corded lamp.....	677
Bodywork component horizontal stand.....	1154
Bodywork component storage stand.....	1134
Bodywork inspection lamp.....	673
Bodywork lock-grip pliers.....	1137
Bolt cropper.....	610
Borehole drill bits.....	603
Bottle holder.....	79
Box of 1" sockets.....	349
Box wrench holder.....	128
Box wrenches for 16 and 21 mm spark plugs.....	1058
Box wrenches with screwdriver handle.....	246
Brake calliper piston pusher.....	1116
Brake fluid tester.....	1112
Brake-spring pliers.....	1116
Brake-spring pliers.....	1186
Brushes.....	1008
BSP female gas tapped snap coupling.....	711
BSP gas threaded conical male coupler with Teflon.....	711
Bumping hammers.....	1147
C	
Calibration sensors for torque tools.....	413
Calibration testers for torque tools.....	411
Calliper class 0 - 1/50th.....	533
Calliper puller.....	646
Canted angle hammers.....	566
Cap wrenches with flats.....	1053
Cape chisels.....	579
Carpenters hammer.....	566
Carrier strap.....	187
Cast iron surface plates.....	538
Caulking gun - 50 x 215 mm cartridge.....	708
Centring square.....	545
Chain pipe wrenches - ADF.....	759
Chain wrenches.....	725
Chalk line reel.....	557
Chest - 4 drawers - 3 modules per drawer.....	70
Chisel holder.....	129
Chisels.....	578
Chisels - ADF.....	755
CHRONO + chests.....	69
CHRONO heavy-duty and safety roller cabinets.....	73
CHRONO+ Roller cabinets.....	68
Clamp tool-holder.....	1006
Clamps.....	738
Cleanliness set for roller cabinets.....	79
Click torque wrenches.....	380
Click torque wrenches.....	375
Click torque wrenches - 20 x 7 mm coupler.....	376
Click torque wrenches with fixed ratchet.....	380
Click torque wrenches without accessories - RFID.....	876
Click torque wrenches without accessories - SLS.....	787
Clip extraction spatula.....	1136
Clip-on ammeter.....	948
Clip-on multimeter.....	948
Clutch center.....	1110
Coax and multipair cable sheath stripper and stripper.....	928
Coax cable sheath-stripper and stripper.....	928
Coax connector crimping pliers.....	939
Cobalt steel bimetal saw blade.....	587
Combination electronic thermometer.....	949
Combination pliers - FLUO.....	832
Combination pliers - RFID.....	888
Combination pliers - SLS.....	793
Combination pliers with retention system - FLUO.....	834
Combination wrenches.....	219
Combination wrenches - ADF.....	743
Combination wrenches - FLUO.....	809
Combination wrenches - RFID.....	852
Combination wrenches - SLS.....	779
Combined set of 10 1/4" bits - series 1 - 25 mm.....	464
Combined set of 10 1/4" bits - series 1 - 25 mm.....	464
Combined set of 10 1/4" Resistor® bits - series 1 - 25 mm.....	464
Combined set of 10 1/4" Torx Plus® bits - series 1 - 25 mm.....	465
Combined set of 10 1/4" Torx® bits - series 1 - 25 mm.....	464
Combined set of 10 Tamper Proof Torx Plus® 1/4" bits - series 1 - 25 mm + bit holder.....	465
Combined set of 28 High Perf® 1/4" bits - series 1.....	465
Common Rail diesel injector return flow tester.....	1081
Compact leather bag.....	177
Compact ratchets - drive 14 x 18 mm.....	400
Compact ratchets - drive 9 x 12 mm.....	398
Composite cap wrench sockets.....	1053
Composite cap wrenches with flats.....	1053
Composite chisels to separate casings.....	1107
Compressor holder.....	1123
Connecting lead.....	1012
Consigning kit for electric and hybrid vehicles.....	1038
Contact cleaning diamond tweezers.....	1073
Contact tip.....	1012
Container foam divider.....	191
Container turnbuckle wrench.....	255
Cooling circuit tester.....	1088
Copper pipe cutter.....	728
Copper-Aluminium ratchet cable cutters.....	612
Corded inspection lamp.....	677
Cordless LED inspection lamp.....	669
Countersunk mill 90°.....	606
CPE series combination pliers.....	490
CPE series diagonal cutters.....	487
CPE series electricians diagonal cutters.....	487
CPE series end nippers.....	487
CPE series flat nose pliers.....	490
CPE series half-round nose pliers.....	489
CPE series half-round slim-profile nose pliers.....	489
CPE series round nose pliers.....	490
Crimping and punch pliers.....	1153
Crimping dies for phone connectors.....	939
Crimping pliers for tubular terminals.....	935
Crimping pliers for tubular terminals with rotating dies.....	936
Crimping pliers for tubular terminals with rotating dies.....	1188
Cross-beam 2 Jetline + units.....	107
Cross-beams 1 foot and 1 Jetline + unit.....	107
Cross-test level.....	553
Cup press.....	1089
Curved spatula.....	1097
Cut All.....	619
Cut bits.....	602
Cut out 3-3 foam trays.....	85
Cut-out body tape measure 20 m.....	552
Cutters - ADF.....	752
Cylinder-head rest.....	1089
D	
DAT VAT safety tester.....	949
Dead-blow drifts.....	570
Dead-blow mallets, interchangeable tips.....	567
Dead-blow mallets, interchangeable tips - FLUO.....	843
Dead-blow mallets, interchangeable tips - SLS.....	800
Deburring-chamfer case set.....	729
Depth gauges class 0 - 1/50th.....	534
Desoldering harness.....	1016
Desoldering pumps.....	1016
Detachable compartmented magnetic shelf + paper roll holder.....	79
Device removal jack 1000 kg.....	1029
Device removal jack 500 kg.....	1028
Diagnostic accessories.....	1064
Diagonal cutters - FLUO.....	831
Diagonal cutters - RFID.....	886
Diagonal cutters - SLS.....	791
Diagonal cutters with retention system - FLUO.....	834
Dial gauge.....	537
Dial gauge-hinged magnetic base set.....	537
Dial gauge-magnetic base set.....	537
Die holder.....	601
Diesel dummy glow plug.....	1077
Diesel engine compression tester.....	1078
Diflex pvc hose diameter 10 x 16 mm + end bits.....	711
Digital brake bleeders.....	1113
Digital display callipers - 1/100th.....	531
Digital display depth gauges 300 mm - 1/100th.....	532
Digital display dial gauge.....	532
Digital display micrometer 25 mm.....	532
Digital heat gun.....	723
Disc brake vernier calliper.....	1111
Disc brake vernier calliper.....	1185
Document holder.....	80
Dolly.....	1149
Double scale torque wrenches in Lbf.In and N.m. - RFID.....	877
Double scale torque wrenches in Lbf.In or Lbf.Ft and N.m.....	376
Double SLS hook.....	768
Double stripping automatic wire cutters-strippers.....	930
Drain plug bit.....	1044
Drain plug bit with XZN pattern.....	1047
Drain plug wrenches.....	1043
Drain-plug wrench and bit set.....	1044
Draining kit.....	1043
Drawer.....	121
Drawer partitions.....	84
Dressers.....	1148
Drift punch.....	575
Drift punch - ADF.....	755
Drift punch - FLUO.....	844
Drift punch - RFID.....	882
Drift punch sets.....	576
Drill bit diameter 11 mm.....	947
Drive squares - coupler 14 x 18 mm.....	400
Drive squares - coupler 20 x 7 mm.....	402
Drive squares - coupler 9 x 12 mm.....	398
Drum brake vernier calliper.....	1111
Dummy injectors.....	1077
Dummy squares and dummy sliding squares.....	556
E	
Electrical engineers 'compact' diagonal cutters.....	493
Electrical engineers diagonal cutters.....	493
Electrical engineers extra long-reach half-round nose pliers.....	518
Electrical engineers half-round nose pliers.....	494
Electricians all-in-one / Set of mobile industrial cable ties.....	933
Electricians diagonal cutters - RFID.....	887
Electricians hammers.....	565
Electricians knife.....	621
Electricians knife - RFID.....	885
Electricians knife - SLS.....	799
Electricians scissors - FLUO.....	844
Electricians set - mobile crimping tool.....	933
Electromechanical technician roller container case.....	192

Inside Circlip® pliers with 'closing' rack	507
Inside grip puller	632
Inside grip puller and beam set	649
Inside puller	650
Inside/outside puller kit	631
Inspection creepers	1036
Inspection mirror	1010
Inspection mirror - FLUO	1010
Inspection mirror - FLUO	845
Instant soldering iron 100 W – 230 V	1015
Insulating gloves	720
Insulating mats	721
Insulating pliers	970
Interchangeable 4-die crimping pliers	932
Interchangeable cylinder	110
Interchangeable steel tip scriber	548
Interchangeable steel tip scriber - SLS	795
Interchangeable-tip mallets	568
Interchangeable-tip mallets - SLS	801
Interchangeable-tip mallets - SLS	801
Iron pipe cutter	727
ISO hollow punch with screw	946
ISO staged drill bit	947
ISORYL screwdriver for slotted-head screws - forged blade - T handle	435
ISORYL screwdriver for slotted-head screws - handle with clasp	435
ISORYL screwdriver for slotted-head screws - milled blade	434
ISORYL screwdriver for slotted-head screws - short blade	435
ISORYL screwdrivers for Phillips® screws	435
ISORYL screwdrivers for Phillips® screws - short blade	436
ISORYL screwdrivers for Pozidriv® screws	436
ISORYL screwdrivers for Pozidriv® screws - short blade	436
J	
Jack foam holder	1022
JET + roller cabinets - 3 modules per drawer	58
JET + roller cabinets - 4 modules per drawer	61
JET + roller cabinets - 5 modules per drawer	64
JET+ chests 4 drawers - 3 modules per drawer	60
JET+ chests 4 drawers - 4 modules per drawer	63
JET+ chests 4 drawers - 5 modules per drawer	66
JET+ Mobile workbench	67
JET+ roller cabinets - E-ACCESS range	71
JET+ roller cabinets - safety range	72
Jetline + angle half-panel (400 mm)	103
Jetline + assembly kit	108
Jetline + beech angle worktop	104
Jetline + brushed stainless steel angle worktop	105
Jetline + cabinets	101
Jetline + cable tray	109
Jetline + elec half-panels (400 mm)	103
Jetline + foot, height 1025 mm	106
Jetline + foot, height 850 mm	106
Jetline + half-panels (400 mm) - 1452 mm	103
Jetline + half-panels (400 mm) - 724.5 mm	103
Jetline + high unit	96
Jetline + high unit with shutter	124
Jetline + high unit, single solid doors and drawers	125
Jetline + light ramp	108
Jetline + low unit	91
Jetline + metal worktop	106
Jetline + panel (800 mm) - 1452 mm	102
Jetline + panel (800 mm) - 724.5 mm	102
Jetline + risers	95
Jetline + top box	99
Jetline + wooden and stainless steel worktop	105
Jetline + wooden worktop	104
Jointed nose tip lock-grip pliers	512
K	
Key file sets	590
Key with 4 cavities for cabinets	941
L	
Lambda probe wrenches and sockets	1095
Lanyard 1.2 m - 80 mm stainless steel double snap hook with screw - SLS	771
Lanyard 1.2 m - retractable loop and 80 mm stainless steel double snap hook with screw - SLS	771
Lanyard 1.2 m steel cable - 80 mm stainless steel double snap hook with screw - SLS	771
Lanyard 20 cm - 60 mm stainless steel double snap hook with screw - SLS	771
Lanyard 20 cm - Stainless steel 50 mm spring hook + swivel and 60 mm stainless steel snap hook with screw - SLS	769
Large offset presses	537
Large-capacity lock-grip pliers	513
Laser telemeter	529
Leather bag	177
Leather case with drawers	193
LED pen light	671
Legs contained in U.312HJ3	637
Legs contained in U.312HJ4	637
Lever grease pump	734
Li-Ion batteries	717
Lifting plate for 500 Kg jack	1029
Lineman's pliers - ADF	753
Lock back knife	620
Lock-back knife - RFID	885
Lock-grip pliers for angle sections	515
Lock-grip pliers for round sections	515
Lockable 2-leg sliding-leg puller	641
Locking clips for CKS hooks	126
Locking ring bit holder	475
Locking ring bit holder - FLUO	829
Locking slip-joint multigrip pliers	500
Locking slip-joint multigrip pliers - FLUO	830
Locking slip-joint multigrip pliers - RFID	886
Locking slip-joint multigrip pliers - SLS	790
Locking-wire pliers	510
Locking-wire pliers - FLUO	841
Locking-wire pliers - RFID	894
Locks	110
Long curved spatula	1098
Long keys	450
Long leg for U.27AS3	634
Long ratcheting tap wrenches	601
Long socket holder - 1/4" drive square - FLUO	829
Long socket holder - 1/4" square drive	476
Long socket holder - 3/8" square drive	476
Long tie-rod for U.27AS3	635
Long-nose automatic lock-grip pliers	514
Long-nose lock-grip pliers	512
Long-nose lock-grip pliers - SLS	794
Long-nose single setting lock-grip pliers	514
Long-reach 10° angled offset ring wrenches	232
Long-reach 15° angled offset ring wrenches	233
Long-reach 15° angled offset ring wrenches - Spline	911
Long-reach hexagon key ring sets	445
Long-reach offset ring wrenches	231
Long-reach ring wrenches	909
Low voltage-tester screwdrivers	442
Low-effort cutters	485
Low-effort diagonal cutters	519
Lubricant	944
Lubricating paste	947
M	
MAC PHERSON clamp separator set	1124
MAC PHERSON damper rod tool set	1124
Magnetic holder for painting small bodywork parts	1155
Magnetic levels	555
Magnetic levels, 1 machined sole plate	555
Magnetic ring bit holder	475
Magnetic snap ring bit holder	475
Magnetic snap ring bit holder - beryllium	475
Magnetic snap ring bit holder - FLUO	828
Magnetic sockets for hex screws	472
Magnetic trapezoidal levels	554
Magnetizer - Demagnetizer	442
Maintenance crimping pliers for pre-insulated terminals	1074
Maintenance leg puller set	650
Maintenance workbench - galvanized steel worktop - 1.5 m	120
Maintenance workbench - galvanized steel worktop - 2 m	120
Maintenance workbench - multi-ply beech worktop - 1.5 m	121
Maintenance workbench - multi-ply beech worktop - 2 m	121
Maintenance workbench - 6 drawers, galvanized steel worktop - 2 m	117
Maintenance workbench - 6 drawers, wooden worktop, 2 m	117
Maintenance workbench 1.5 m	119
Maintenance workbench 2 m	118
Maintenance workbench 2 m with drawers	118
Mallet body	569
Manual Copper-Aluminium cable cutters	612
Manual oil syringe	734
Manual pressure/vacuum pump	1075
Manual reset torque wrenches	381
Manual reset torque wrenches	382
Manual reset torque wrenches with square drive and handle	381
Mechanical component storage stand	1134
Mechanics hammers	563
Mechanics hammers - RFID	883
Mechanics riveting hammer with graphite grip - FLUO	843
Mechanics riveting hammers	563
Mechanics riveting hammers - RFID	883
Metal cases	184
Metal rings - SLS	774
Metal shears	608
Metal tool boxes	180
Metric "T" socket universal joint wrenches with slide handle	247
Metric "T" socket wrenches with slide handle	247
Metric double-ended forged socket wrenches	244
Metric flare-nut wrenches angled at 15°	252
Metric forged socket wrenches with "T" handle	246
Metric forged socket wrenches with screwdriver handle	245
Metric forged socket wrenches with screwdriver handle - FLUO	812
Metric forged socket wrenches with screwdriver handle - RFID	859
Metric hexagon T-handle spinner keys - SLS	789
Metric hinged socket wrenches	249
Metric long combination wrenches	223
Metric open end bits - drive 9 x 12 mm	399
Metric straight flanged flare-nut wrenches	251
Metric straight flanged flare-nut wrenches	250
Metrology-control set	536
Micro-Tech® 'low torque' screwdrivers	393
Micro-Tech® 'Production' torque screwdriver	395
Micro-Tech® cutters	978
Micro-Tech® diagonal cutters - ESD	988
Micro-Tech® diagonal cutters - FLUO	836
Micro-Tech® diagonal cutters - RFID	889
Micro-Tech® electronic torque screwdriver sets	393
Micro-Tech® grippers	982
Micro-Tech® grippers - FLUO	838
Micro-Tech® grippers - RFID	889
Micro-Tech® hexagonal key 4 mm bit holder screwdriver	994
Micro-Tech® hexagonal key screwdriver	994
Micro-Tech® hexagonal key set	998
Micro-Tech® joint vice	1007
Micro-Tech® replaceable blade screwdrivers	994
Micro-Tech® saw frame	1006
Micro-Tech® screwdriver set	996
Micro-Tech® screwdrivers for Phillips® and Pozidriv® head	993
Micro-Tech® screwdrivers for slotted head screws	994
Micro-Tech® screwdrivers for Torx® screws	993
Micro-Tech® tool set	999
Micrometers 1/100 mm accuracy	535
Mid-height work seat	921
Mill	1071
Milled files	1150
Mini bolt cropper	612
Mini copper pipe cutter	728
Mini mechanical set	1121
Mini wire grip	1012
Mixed thermometer	1064
Mobile crimping pliers	932
Modular sets with sockets	382
Monkey wrenches	259
Monkey wrenches - ADF	759
Motorist pliers - ADF	753
Muffler core remover	1128
Muffler for HGV wheel deflating	1128
Multi-cavity cross brace	941
Multi-diameter damper pulley puller	1109
Multi-diameter timing and injection pump pulley puller	1109
Multi-functional bodywork support cradle	1153
Multi-make electronic belt tension-meter	1108
Multi-purpose angle-nose automatic lock-grip pliers	513
Multi-purpose drift punch holder	128
Multi-purpose holder for stud pullers	128
Multi-purpose key holder	128
Multi-purpose screwdriver holder	128
Multifunction brush	698
Multifunction sheath stripper	928
Multifunction trigger sheath-stripper	926
Multifunction trigger sheath-stripper - SLS	799
Multimeter	948
Multimeter megohmmeter and insulation tester	1063
Multiple diameter piston pushing tools	1116
Multiple function hook	1096
Multiple grip pliers - ADF	752
Multiple grip pliers - FLUO	830
Multiple grip pliers - RFID	886
Multiple grip pliers - SLS	791
Multiple make broken electrode puller set	1083
Multiple opening straight ratchet offset-ring wrenches	215
Multiple use carrier trolley	185
N	
Nail-sets	577
Natural Briçon chalk sticks	557
Needle file sets	597
Needle holder casing	943

Screw	1131	Sets of Protwist® screwdrivers	418	Spherical head P-handle keys	453
Screw bits for countersunk hex head screws	459	Sets of sheathed impact tools	573	Spherical head spinner hexagon keys	456
Screw bits for countersunk hex spherical head screws	459	Sets of short-reach combination ratchets in portable case	208	Spherical head spinner hexagon keys - FLUO	824
Screw bits for Phillips® screws	459	Sets of short-reach combination wrenches	222	Spinner keys - ADF	751
Screw bits for Pozidriv® screws	459	Sets of straight ratchet offset-ring wrenches	211	Spiralled polyurethane extension	710
Screw bits for slotted head screws	459	Sets of straight ring wrenches	234	Spline 15° angled offset-ring ratchets	909
Screw bits for Torx® screws	459	Sets of Torx® wrenches in wallet	445	Spline 15° angled offset-ring ratchets	213
Screw bits series 0 - drive 4 mm	995	Sets of wood handle screwdrivers	436	Spring compressor forks	1120
Screw for UWG jack	639	Sheath strippers	927	Spring compressor with interchangeable forks	1122
Screw pitch gauges	539	Sheathed automatic centre punch	574	Spring compressors workstation (naked)	1123
Screw starter	1060	Sheathed cape chisels	574	Spring holder	1116
Screw starter	443	Sheathed centre punches	573	Spring puller	1007
Screw starter for Phillips® screws	443	Sheathed centre punches - SLS	802	Square bastard files with handle	595
Screw starter for slotted heads	443	Sheathed chisels	574	Square face dingling hammer	564
Screw starter for slotted-head screws	443	Sheathed chisels - SLS	802	Square piston ring compressor	1183
Screw-on dummy injectors	1077	Sheathed nail punches	572	Square semi-cut files with handle	594
Screw-type hose clamps	1088	Sheathed nail punches - SLS	801	Square tips	549
Screwdriver rack	418	Sheathed nail punches - SLS	572	Stainless body 2 metre tape measure	551
Screwdriver sockets with 6 grooves	335	Sheathed nail-sets - SLS	802	Stainless steel basic precision squares - Class 0	543
Screwdrivers for Philips® heads ADF	750	Sheet metal - bodywork workstation	1145	Stainless steel flanged precision squares - Class 0	543
Screwdrivers for Pozidriv® heads ADF	750	Sheet metal - bodywork workstation	74	Stainless steel flexible rule - 2 faces - FLUO	842
Screwdrivers for slotted heads ADF	750	Shelf for A1000 cabinets	109	Stainless steel flexible rule - 2 faces - RFID	882
Scriber	547	Shelf for A500 cabinets	109	Stainless steel flexible rules - 1 side	542
SE series 1000 Volt insulated hacksaw frame	960	Shelf for high units MHS	110	Stainless steel flexible rules - 2 faces - SLS	795
Sealed roller boxes - Flycase	188	Shock absorber removal lever	1124	Stainless steel flexible rules - 2 sides	541
Secured impact wrenches	237	Shop digital display calliper	531	Stainless steel joiners squares	556
Seized Common Rail injector inertia puller	1082	Short 10° angled offset ring wrenches	232	Stainless steel lock back knife	621
Seized common rail injector screw puller	1082	Short combination wrenches	221	Stainless steel pipe cutter	727
Self-gripping slim leg outside pullers	632	Short combination wrenches - FLUO	809	Stainless steel semi-rigid 'long' rules - 1 side	542
Self-gripping wide leg outside pullers	645	Short combination wrenches - RFID	853	Stainless steel semi-rigid 'short' rules - 2 sides	542
Self-tightening clamp pliers	1086	Short hexagon key ring sets	445	Stainless steel snap hook - SLS	774
Semi-cut square files	594	Short keys	450	Standard bits series 1 for BNAE head screws	463
Separator	1007	Short ratchet combination wrenches	208	Standard bits series 1 for countersunk hex screws	462
Separator and beam set	653	Short ratchet combination wrenches - SLS	781	Standard bits series 1 for countersunk hex screws - FLUO	827
Separators	654	Short ratcheting tap wrenches	601	Standard bits series 1 for Phillips® screws	460
Serkan 360	937	Short Resistor® keys	453	Standard bits series 1 for Pozidriv® screws	460
SERKAN® ratchet crimping pliers for pre-insulated terminals	934	Short snap ring bit holder	475	Standard bits series 1 for Resistor® screws	461
Set for alternator pulleys	1110	Short Torx® keys	452	Standard bits series 1 for Robertson® square head screws	460
Set for fitting / removing flexible belts	1110	Short XZN® keys	457	Standard bits series 1 for slotted head screws	460
Set of 100 test cards for diesel engine	1078	Short-nose lock-grip pliers	512	Standard bits series 1 for Tamper Resistant Torx Plus® screws	461
Set of 15° angled head 'micromechanic' open end wrenches	227	Short-nose lock-grip pliers - SLS	794	Standard bits series 1 for Torq Set® head screws	463
Set of 2 wrench adapters 10 mm to 1/4" square drive	213	Short-nose single setting lock-grip pliers	514	Standard bits series 1 for Torq Set® head screws - FLUO	828
Set of 2 wrench adapters to 1/4" and 1/2" square drive	213	Simple open end wrench	228	Standard bits series 1 for Torq Set® head screws - FLUO	828
Set of 3/8" sockets in case	310	Single effect oil cans	735	Standard bits series 1 for Torx Plus® screws	461
Set of 3/8" sockets on metallic rack	310	Single key option for Jetline + furniture	108	Standard bits series 1 for Torx® screws	460
Set of angled keys for multiple XZN teeth	457	Single position lock-grip pliers	512	Standard bits series 1 for Torx® screws - FLUO	827
Set of cage gasket centres	1087	Single shelf for low units MBS	110	Standard bits series 1 for Tri-Wing head screws	463
Set of chisels and cape chisels on holder	579	Single spoon	1150	Standard bits series 1 for Tri-Wing head screws - FLUO	828
Set of greasing end bits	735	Sledge hammer	566	Standard bits series 1 for XZN multiple teeth head screws	462
Set of heavy-duty ring wrench set	236	Sledgehammers - ADF	754	Standard bits series 1 with spherical head for countersunk hex screws	462
Set of hexagon spinner keys	457	Sleeving pliers	940	Standard bits series 2 for BNAE head screws	470
Set of metric combination and long-reach wrenches	223	Slide hammer 9,8 Kg	1131	Standard bits series 2 for countersunk hex screws	469
Set of metric double-ended forged socket wrenches	244	Slide hammers	652	Standard bits series 2 for Phillips® screws	469
Set of metric ratchet combination wrenches	204	Sliding 2-leg sliding-leg puller	643	Standard bits series 2 for Pozidriv® screws	469
Set of metric straight flanged flare-nut wrenches	251	Slim LED inspection lamp	672	Standard bits series 2 for slotted head screws	469
Set of mills	1140	SLS HOOK wrist bracelet	768	Standard bits series 2 for Torq Set® head screws	470
Set of multi-diameter forks	1122	Small dimension presses	737	Standard bits series 2 for Torx® screws	469
Set of pictograms	84	Small grease pump	734	Standard bits series 2 for XZN multiple teeth head screws	470
Set of plastic component removal tools	1136	Snap ring bit holder sockets	475	Standard bits series 6 for countersunk hex screws	471
Set of pullers for deformed glow plugs	1107	Snap ring bit holder sockets for 1/4" - 6.35 mm hex series 1 bits	474	Standard bits series 6 for countersunk hex screws - FLUO	827
Set of roller-type stud drivers	662	Snap ring bit holder sockets for 5/16" - 7.94 mm series 2 bits	474	Standard bits series 6 for Phillips® screws	470
Set of sheathed tools	575	Socket for PSA lower ball joint castle nut	1129	Standard bits series 6 for Pozidriv® screws	471
Set of spare screws	1111	Socket holder	129	Standard bits series 6 for ROBERTSON square head screws	471
Set of spare screws	509	Socket holder - 1/4" drive square	476	Standard bits series 6 for slotted head screws	470
Set of spherical head spinner hexagon keys	456	Socket holder - 1/4" drive square - FLUO	829	Standard bits series 6 for slotted head screws - FLUO	826
Set of stud pullers	660	Socket holder - 3/8" drive square	476	Standard bits series 6 for Torq Set® head screws	471
Sets of 'extra-slim' open-end wrenches	226	Socket holder bit	996	Standard bits series 6 for Torq Set® head screws - FLUO	828
Sets of 'micromechanic' open-end wrenches in wallet	227	Socket holder bit - 1/4"	394	Standard bits series 6 for Torx® screws	471
Sets of 'T' socket universal joint wrenches with slide handle	248	Socket holder bit - 1/4" drive - 1/4" 6-point	474	Standard bits series 6 for Torx® screws - FLUO	827
Sets of 1/2" sockets on metallic rack	324	Socket holder bit 4 mm - 1/4"	394	Standard CKS hook	126
Sets of 1/4" sockets in case	293	Socket holder bit 4 mm - 1/4"	460	Standard crimping pliers for pre-insulated terminals	935
Sets of 1/4" sockets on metallic rack	292	Sockets for 1/2" square drive Diesel injectors	1084	Standard crimping pliers for pre-insulated terminals - FLUO	840
Sets of angled box wrenches	243	Sockets for hex screws	472	Standard crimping pliers for pre-insulated terminals - RFID	894
Sets of angled open-socket wrenches	241	Soft cases	194	Standard crimping pliers for pre-insulated terminals - SLS	794
Sets of combination ratchets in portable case	204	Soldering iron stand	1013	Standard drifts	570
Sets of combination wrenches	220	Solid stainless steel rules	541	Standard levels, 1 machined sole plate	555
Sets of flare-nut ratchet wrenches	250	Spare bits for mallets	569	Standard long bits series 2 for countersunk hex screws	469
Sets of forged socket wrenches with screwdriver handle	245	Spare blades for bolt croppers	611	Standard long bits series 2 for XZN multiple teeth head screws	470
Sets of hinged combination ratchets in portable case	210	Spare legs for U.32T	642	Standard mechanical set	1121
Sets of ISORYL screwdrivers	434	Spare strap	726	Standard multigrip pliers	502
Sets of metric combination wrenches in portable case	220	Spare tie rods for jib	656	Standard trapezoidal levels	555
Sets of metric offset combination wrenches	223	Spare tips for circlip® pliers 467 and 469	509	Standard wire end crimping pliers	938
Sets of metric tube wrenches	242	Spark plug jointed wrenches for 16, 19 and 21 mm spark plugs	1058	Starting booster fuse	1068
Sets of offset ring wrenches	230	Spark plug lead pliers	1058	Steady-spring tool	1117
Sets of open-end wrenches	225	Special workbench vice	1123	Steel cable cutter	613
Sets of PROTWIST® 1000 Volt insulated screwdrivers	430	Spherical head long-reach keys	449	Steel scriber	548
Sets of PROTWIST® 1000 Volt insulated screwdrivers	955	Spherical head long-reach Torx® keys	452	Steel scriber - FLUO	842
Sets of PROTWIST® BORNEO® screwdrivers for mixed heads	433	Spherical head metric hexagon keys - FLUO	825	Steel wire basket	187

ALPHABETIC INDEX

Steel wire brush.....	1141
Steel wire brush.....	721
Stepped bits.....	603
Sterilizable tweezers.....	1004
Sticks of all-purpose glue.....	1146
Storage holder for cylinder head.....	1092
Straight curved spatula.....	1098
Straight frame with blade backing.....	586
Straight pneumatic grinder 0.3 HP with 6 mm collet.....	700
Straight pneumatic grinder 0.5 HP with 6 mm collet.....	699
Straight pneumatic grinder with 6 mm collet.....	700
Straight pneumatic grinder with shank extension 0.3 HP with 6 mm collet.....	699
Straight pneumatic grinder with shank extension 0.5 HP with 6 mm collet.....	700
Straight ratchet offset-ring wrenches.....	211
Straight ratchet offset-ring wrenches - FLUO.....	810
Straight ratchet offset-ring wrenches - RFID.....	856
Straight ratchet ring wrench opening 14 and 19 mm.....	215
Straight ring wrenches.....	234
Straight spatula.....	1098
Straight tip.....	1097
Straight Torx® ring wrenches.....	234
Strippers for coax cables types RG.58, RG.59 and RG.62.....	928
Stud extraction drill-bits and pullers.....	661
Stud extractors set.....	659
Stud pullers.....	660
Suction cup inertia puller by manual pump.....	1146
Suction cup inertia puller by venturi.....	1146
Support for 6 posts.....	1041
Support for large van organization - FSVANL.....	170
Support for moving vehicles with no steering gear.....	1135
Support for standard van organization - FSVAN.....	170
Surface preparation workstation.....	1154
Surface preparation workstation.....	74
SWINGO 90° automatic strippers and cutters.....	929
SWINGO® automatic strippers.....	929
Swivel handle.....	403
Swivel handles - drive 20 x 7 mm.....	402
Synthetic blade rule Class III 2 meters - 10 branches.....	556

T

T-handle keys.....	456
T-handle Torx® spinner keys - SLS.....	790
Tap and drill-bit sets.....	600
Tap, die and tool holder sets.....	600
Tape measure 50 m.....	553
Taps.....	598
Technicians case.....	191
Telescopic mirror with magnifying effect.....	922
Telescopic mirror with magnifying effect.....	1011
Telescopic mirrors.....	1011
Telescopic mirrors.....	922
Temperature probes.....	949
Thread repair insert kit.....	1096
Thread restoring tools.....	600
Threaded adaptors.....	656
Threaded bit couplers.....	656
Three-square scraper.....	606
Timing kit.....	1101
Timing kit for PSA 1.0L and 1.2L petrol engines.....	1104
Timing kit for VAG 1.0L petrol engines.....	1106
Tip type puller - inside grip.....	648
TOOL BOX.....	172
Tool carry bag - SLS.....	775
Tool for fitting / removing filter elements.....	1085
Tool storage foam modules for drawers.....	145
Tool storage heat formed modules for drawers.....	130
Tools for cylinder heads fitted with glow plugs.....	1084
Tools for Truarc® rings.....	1005
Torch.....	675
Torque and angle torque couplers.....	391
Torque drivers with adjustment Vernier.....	393
Torque multiplier sets.....	385
Torque multipliers.....	385
Torque reading electronic torque wrenches.....	396
Torque screwdriver sets.....	394
Torque screwdriver torque meters.....	413
Torque tool calibration bench.....	413
Torque wrench couplers - 20 x 7 mm coupler.....	402
Torx® key ring sets.....	445
Torx® key ring sets.....	448
Tough System mobile chest.....	167
Tough System organizer case.....	166
Tough System tool basket.....	166
Tough System tool boxes.....	164
Tough System trolley.....	168
Tough System worksite radio.....	167
TOUGHSYSTEM box stand.....	80

TOYOTA oil filter plug cap.....	1055
TPMS valve set.....	1130
Transmission collar clamps.....	1111
Transmission collar clamps.....	1129
Triangle bastard files with handle.....	596
Triangle semi-cut files.....	595
Triangle semi-cut files with handle.....	595
Trim removal tools.....	1135
Tripod for SPOT lamp.....	676
Trolley and workshop supports.....	168
Trolley jacks.....	1167
Tropicalized steel turret.....	944
Tweezers.....	1001
Twin slip-joint multigrip pliers.....	502
Two-vial level.....	553
Tyre remover.....	1128
Ultra compact multi-tightening ratchet set.....	209
Universal 'LV-LCV' trolley jacks.....	1021
Universal calliper - 150mm - 1/20th.....	534
Universal calliper - 300 mm - 1/50th.....	534
Universal callipers class 0 - 1/50th.....	533
Universal funnel.....	1044
Universal joint pusher - hydraulic hub puller.....	1130
Universal joint pusher - mechanical hub puller.....	1130
Universal plug for bleeding LV and HGV brakes and clutches.....	1114
Universal pulley wrench.....	1109
Unstapling pliers.....	1135
US chest - 8 drawers, black.....	75
US Roller cabinets.....	75
Utility knife with 18 mm automatically reloading blade - RFID.....	884
Utility knife with 18 mm snap-off blade.....	616
Utility knife with 9 mm snap-off blade.....	616
Utility knife with Micro-Tech® interchangeable blade.....	1006
UV torch.....	675

V

Vacuum cooling circuit fillers.....	1087
Valve core remover.....	1128
Valve grinder.....	1090
Valve lifter.....	1088
Valve retaining ring pliers.....	1090
Valve stem seal pliers.....	1090
Valve wrenches - ADF.....	759
Van supports.....	170
Vapour extractor.....	1085
Variable pitch hole saws.....	605
Variable-pitch holesaw with chuck sets.....	605
Varnished wire strippers.....	931
VE series 1000 Volt insulated combination pliers.....	497
VE series 1000 Volt insulated diagonal cutters.....	495
VE series 1000 Volt insulated electricians diagonal cutters.....	496
VE series 1000 Volt insulated end nippers.....	496
VE series 1000 Volt insulated flat nose pliers.....	498
VE series 1000 Volt insulated half-round long nose pliers.....	497
VE series 1000 Volt insulated half-round short nose pliers.....	497
VE series 1000 Volt insulated round nose pliers.....	498
VE series 1000 Volt insulated strippers.....	498
Vertical board for JET+ roller cabinets.....	82
Vertical sander with rotating plate 178 mm.....	697
Very low voltage-tester screwdrivers.....	442
Very sharp stubby blade scissors.....	1005
Vibrating sander - 95 x 170 mm - 8 holes.....	1155
Vibrating sander - 95 x 170 mm - 8 holes.....	696
Vice for lower grip on MacPherson strut.....	1120
Vice holder.....	81
VSE series 1000 Volt insulated 1/2" ratchet.....	967
VSE series 1000 Volt insulated 3/8" ratchet.....	965
VSE series 1000 Volt insulated adjustable wrenches.....	962
VSE series 1000 Volt insulated box wrenches.....	962
VSE series 1000 Volt insulated combination pliers.....	958
VSE series 1000 Volt insulated copper-alu cable cutter.....	960
VSE series 1000 Volt insulated diagonal cutters.....	957
VSE series 1000 Volt insulated end nippers.....	958
VSE series 1000 Volt insulated flat nose pliers.....	958
VSE series 1000 Volt insulated hexagon keys.....	962
VSE series 1000 Volt insulated knife.....	961
VSE series 1000 Volt insulated multigrip pliers.....	957
VSE series 1000 Volt insulated offset ring wrenches.....	961
VSE series 1000 Volt insulated open end wrenches.....	961
VSE series 1000 Volt insulated ratchet cable cutter.....	960
VSE series 1000 Volt insulated round nose pliers.....	959
VSE series 1000 Volt insulated semi-round nose pliers.....	959
VSE series 1000 Volt insulated strippers.....	959
VSE series 1000 Volt insulated tools set.....	964
VSE series 1000 Volt insulated torque wrenches.....	969

W

Wall-mounted cupboard.....	125
Wallet sets of angled Torx® keys.....	447
Wallet sets of hexagon keys.....	447
Wallet sets of hexagonal keys.....	444
Waste bin.....	79
Welders chipping hammers.....	565
Welding spot mill.....	1140
Welding spot mill.....	708
Welding squares.....	403
Wheel nut cross braces for HGV.....	1186
Wheel nut cross braces for LV.....	1125
Windshield cutter.....	1161
Windshield cutter blades CAD.P300F.....	1161
Windshield replacement kit.....	1160
Windshield tools.....	1160
Windshield wiper arm remover.....	1159
Wire basket.....	129
Wire brush.....	1114
Wire cutter and stripper.....	931
Wire end crimping pliers.....	937
Wire strippers.....	491
Wood handle screwdriver for Phillips® screws - hexagonal blade.....	437
Wood handle screwdriver for Pozidriv® screws - hexagonal blade.....	438
Wood handle screwdrivers for slotted head screws - forged blade.....	437
Wood handle screwdrivers for slotted head screws - hexagonal forged blade.....	437
Wood handles for files and rasps.....	589
Wooden worktop for CHRONO.....	83
Wooden worktop for JET+.....	83
Woodwork hammers.....	565
Workbench with 1.5 m vertical panel.....	119
Worksite organization support FSWORKSHOP.....	169
Worksite-maintenance vices.....	736
Wrap-around protection glasses.....	721
Wrecking bars.....	722
Wrench for nuts with top holes.....	255
Wrench for nuts with top slots.....	255
Wrist bracelet with metal ring - SLS.....	769

X

XL fastener stand.....	82
XL filter pliers.....	1185
XL side cupboard.....	81

Y

Yellow and black consigning posts.....	1040
--	------

ALPHANUMERIC INDEX

CR.SSH.....	1146	DCR.IP.....	1081	DL.500EU.....	1028	DX.12R.....	949
CR.T3XL.....	74	DCR.IP-DA.....	1081	DL.50SUP.....	1029	DX.145.....	1073
CR.T4XL.....	74	DCR.IPM.....	1082	DL.5BTI.....	1025	DX.25.....	1074
CT-ACC.....	774	DCR.IPPSA.....	1082	DL.8BTI.....	1025	DX.8.....	1070
CT-ACC2M.....	774	DCR.IPREN.....	1082	DL.C3.....	1026	DX.CONECT.....	1064
CT100-140.....	772	DCR.IT.....	1081	DL.C6.....	1026	DX.RDJ12.....	1073
CT70-100.....	772	DCR.SR.....	1083	DL.PL10A.....	1024	DX.SET.....	1064
		DE.66-18.....	1053	DL.PL22A.....	1026	DX.T100.....	949
		DE.8.....	1096	DL.PL5.....	1023	DX.V12.....	1062
		DE.96-18.....	1053	DLS.300-03.....	1123		
■ D		DE.C.....	1096	DLS.400.....	1123	■ E	
D.1.....	1090	DELA.1021.....	542	DLS.40A.....	1124	E.110.....	464
D.104B.....	1117	DELA.1051.F.....	842	DLS.500-02HP.....	1120	E.111.....	464
D.106-10.....	1046	DELA.1051.03RFID.....	882	DLS.500.....	1119	E.112.....	464
D.109-10.....	1047	DELA.1051.....	541	DLS.500-HP.....	1120	E.113.....	464
D.110.....	1060	DELA.1056.....	542	DLS.500HP.....	1119	E.114.....	465
D.115A.....	1135	DELA.1208.....	556	DM.10A.....	1090	E.116.....	465
D.120-16.....	1047	DELA.1223.....	556	DM.14.....	1111	E.120.....	465
D.132B.....	1084	DELA.1256.....	544	DM.16.....	1108	E.2000.....	411
D.137A.....	1136	DELA.1257.....	544	DM.17A.....	1109	E.2002B.....	723
D.138.....	1129	DELA.1272.....	545	DM.20.....	1060	E.2015.....	723
D.139.....	1053	DELA.1290.00.....	545	DM.25.....	1086	E.306-135D.....	390
D.13A.....	1047	DELA.1292.00.....	545	DM.27.....	1086	E.306-200D.....	390
D.140.....	1053	DELA.13299.....	557	DM.28.....	1058	E.306-30D.....	390
D.141.....	1053	DELA.1589.00A.....	548	DM.29.....	1086	E.306-340D.....	390
D.143B.....	1129	DELA.1786.00.....	539	DM.30.....	1110	E.306A135J.....	390
D.144.....	1085	DELA.1787.00.....	539	DM.30PL.....	1186	E.306A135S.....	390
D.145A.....	1095	DELA.1790.00.....	539	DM.33.....	1088	E.306A200S.....	390
D.146A.....	1095	DELA.1880.00.....	546	DM.34.....	1088	E.306A30R.....	390
D.149.....	1051	DELA.1897.02.....	546	DM.34GM.....	1088	E.306A340S.....	390
D.151A.....	1051	DELA.1901.....	547	DM.360.....	410	E.316-135D.....	391
D.151PL.....	1051	DELA.1905.05.....	547	DM.370.....	410	E.316-200D.....	391
D.154.....	1053	DELA.2883.04.....	553	DM.50.....	1109	E.316-30D.....	391
D.155.....	1053	DELA.3151.01.....	553	DM.7.....	1090	E.316-340D.....	391
D.156.....	1053	DELA.3180.....	553	DM.90.....	1088	E.316A135J.....	391
D.157.....	1053	DELA.3224.00.....	556	DM.91.....	1088	E.316A135S.....	391
D.159.....	1053	DELA.3298.....	557	DM.APR.....	1110	E.316A200S.....	391
D.160.....	1053	DELA.3310.00.....	557	DM.CC.....	1085	E.316A30R.....	391
D.161.....	1053	DELA.3400.00.....	557	DM.ES.....	1075	E.316A340S.....	391
D.162.....	1053	DELA.35.00EX.....	551	DM.F.....	1086	E.406.....	391
D.163.....	1053	DELA.401.....	556	DM.FR1.....	1052	E.506-135S.....	391
D.163-J6.....	1053	DELA.62881.02C.....	552	DM.FR2.....	1085	E.506-200S.....	391
D.164.....	1053	DEPT.....	1055	DM.JL.....	1085	E.506-340S.....	391
D.169.....	289	DF.101.....	1113	DM.MUB-A.....	1086	E.6000-C.....	412
D.1VAG.....	1044	DF.16.....	1112	DM.PS4.....	1107	E.611.....	465
D.1VAG-B.....	1044	DF.17.....	1115	DM.SPRAY.....	1163	E.612.....	465
D.1VAG-H.....	1044	DF.17-100A.....	1115	DM.UES.....	1075	E.900B.....	723
D.22B.....	1123	DF.18-01.....	1111	DM.UOF.....	1044	EA.....	569
D.27A.....	1084	DF.19-01.....	1111	DMP.360L.....	1094	EB.....	569
D.28B.....	1160	DF.2.....	1116	DOT.....	1112	EBNA.1.....	463
D.3-12.....	722	DF.20-07A.....	1114	DP.102-14.....	1053	EBNA.2.....	470
D.3-18.....	722	DF.20-12A.....	1114	DP.106-15.....	1183	EC.25.....	569
D.3-24.....	722	DF.2007D.....	1114	DP.76.....	1053	ECAR.1.....	460
D.3-30.....	722	DF.23.....	1116	DP.88-16.....	1053	ECAR.6.....	471
D.3-300.....	1128	DF.3.....	1114	DR.SIL.....	1128	ECR.....	394
D.3-400.....	1128	DF.475A.....	1117	DR.SILH.....	1128	ECR.0.....	394
D.3-500.....	1128	DF.6.....	1116	DR.V2.....	1130	ED.000.....	459
D.3-600.....	1128	DF.81.....	1113	DRD.B.....	593	ED.001.....	459
D.3-7.....	722	DF.HUP.....	1185	DRD.MD.....	592	ED.0X2.....	459
D.34B.....	335	DL.1000.....	1029	DRD.MDSR.....	756	ED.1.....	460
D.34BL.....	335	DL.1050.....	1025	DRD.MDSLS.....	797	ED.1T.....	466
D.34J7.....	1091	DL.12BTI.....	1025	DS.J5.....	1124	ED.1TF.....	826
D.360L.....	1094	DL.1500.....	1024	DT.CLE.....	1109	ED.13T.....	468
D.3J3.....	722	DL.1530C.....	1025	DT.FIAT.....	1101	ED.2.....	469
D.48.....	1043	DL.15AL.....	1022	DT.FORD.....	1102	ED.601T.....	472
D.48-KIT.....	1043	DL.16P.....	1027	DT.HERTZ.....	1108	ED.6TF.....	826
D.51.....	1090	DL.200SECUA.....	1023	DT.OPEL-D1.....	1102	ED.6TF.....	826
D.79A.....	1116	DL.20BTI.....	1025	DT.PCM-P1.....	1104	ED.603T.....	472
D.80.....	1160	DL.25AL.....	1022	DT.PCMB-D1.....	1104	ED.6TF.....	826
D.83C.....	143	DL.275.....	1024	DT.PSA.....	1103	ED.631T.....	473
D.86.....	1107	DL.2A2L.....	1023	DT.REN.....	1105	ED.632T.....	473
D.93.....	1128	DL.2BTI.....	1025	DT.SFB.....	1110	ED.633T.....	473
DA.160.....	1075	DL.2LP.....	1021	DT.TW.....	1109	ED.661.....	471
DB1.RFID.....	851	DL.30BTI.....	1025	DT.VAG.....	1105	ED.662.....	471
DCR.20J6.....	1161	DL.32A.....	1021	DTS.....	921	ED.663.....	471
DCR.HC10.....	1084	DL.32A-SUP.....	1022	DX.10A.....	1062	ED.691.....	471
DCR.HR-100.....	1107	DL.3CLP.....	1021	DX.12.....	949	ED.693.....	471
DCR.HR-EU.....	1083	DL.50.....	1028				
DCR.ICA.....	1083						

ED.T	1151	EP.6TF	826
ED1.J3	467	EP.63T	473
ED101T.J3	467	EP.66	470
ED102T.J3	467	EP.69	470
ED103T.J3	467	EPT	1151
ED131T.J3	468	EP1.J3	467
ED133T.J3	468	EP101T.J3	467
ED601T.J3	473	EP102T.J3	467
ED603T.J3	473	EP103T.J3	467
ED631T.J3	473	EP131T.J3	468
ED632T.J3	473	EP132T.J3	468
ED633T.J3	473	EP133T.J3	468
EF.6DL	472	EP601T.J3	473
EF.6DML	472	EP603T.J3	473
EF.6J	476	EP631T.J3	473
EF.6JL	476	EP632T.J3	473
EF.6P	475	EP633T.J3	473
EF.6PF	828	ES.0	459
EF.6R	476	ES.1	460
EF.6RF	829	ES.1T	466
EF.6RL	476	ES.1TF	826
EF.6RLF	829	ES.175.5T	468
EF.J	307	ES.2	469
EF.JF	828	E.S401	396
EF.R	289	E.S401J1	396
EFS	331	E.S404	396
EFPZ	463	E.S404J1	396
EH	1151	ES.6	470
EH.00	459	ES.63TF	826
EH.1	462	ES.T	1151
EH.1TF	827	ES1.J3	467
EH.201/4	469	ES134.5T.J3	467
EH.203/8	469	ES134T.J3	467
EH.204	469	ES135.5T.J3	467
EH.204L	469	ES136.5T.J3	467
EH.205	469	ES148T.J3	467
EH.205/16	469	ES603.J3	472
EH.205L	469	ES604.5.J3	472
EH.206	469	ES604.J3	472
EH.206L	469	ES605.5.J3	472
EH.207L	469	ES606.5.J3	472
EH.208	469	ES608.J3	472
EH.208L	469	ETOR.10	463
EH.210	469	ETOR.10TF	828
EH.210L	469	ETORM.10	463
EH.3/32TF	827	ETORM.10TF	828
EH.5/64TF	827	ETORM.11	463
EH.601/8TF	827	ETORM.20	470
EH.603	471	ETORM.21	470
EH.603/16TF	827	ETORM.60	471
EH.603TF	827	ETORM.60TF	828
EH.604	471	ETORM.61	471
EH.605	471	ETRI.10	463
EH.605/32TF	827	ETRI.10TF	828
EH.605TF	827	ETS.00	459
EH.606	471	ETS.10	462
EH.607/32TF	827	EV.10	462
EH.608	471	EV.11	462
EH1.J3	462	EV.20L	470
EH10.J3	462	EV.20	470
EH60.J3	471	EV.21	470
E.LM30	529	EV.21L	470
END.2	477	EV.BAP	1040
ENH.2	477	EV.BAP-RN	1040
ENH.3	478	EV.CH	1040
ENP.20	476	EV.CH-RN	1040
ENS.20	476	EV.JET-KIT	1041
ENS.21	476	EV.JET-SUP	1041
ENS.31	478	EV.PP	1040
ENX.2	477	EX.0	459
EP.000	459	EX.1	460
EP.0X2	459	EX.1TF	827
EP.1	460	EX.2	469
EP.1T	466	EX.2L	469
EP.1TF	826	EX.6TF	827
EP.13T	468	EX.6	471
EP.20	469	EX108.J3	461
EP.6T	472	EX11.J3	461

EX110.J3	461	J.161-4P6	297
EX115.J3	461	J.161B	303
EX12.J3	461	J.202A	382
EX120.J3	461	J.203A	381
EX125.J3	461	J.203DA	381
EX127.J3	461	J.203E	402
EX130.J3	461	J.205E	382
EX140.J3	461	J.208	305
EX610.J3	472	J.208-50	380
EX615.J3	472	J.208-50D	380
EX620.J3	472	J.208A50	380
EX625.J3	472	J.208RFID	866
EX630.J3	472	J.209	305
EX640.J3	472	J.209RFID	866
EXP.1	461	J.209S	306
EXR.1	461	J.210	305
EXR.1L	461	J.210AVSE	966
EXRP.1	461	J.210RC	306
		J.210RCRFID	866
		J.210S	306
		J.215	305
		J.215AVSE	966
		J.215RC	306
		J.215RCRFID	866
		J.216	306
		J.217	305
		J.217RC	306
		J.217RCRFID	866
		J.228	305
		J.229A	305
		J.230	307
		J.230RFID	867
		J.232	307
		J.232RFID	867
		J.235	307
		J.236	307
		J.240A	306
		J.240ARFID	867
		J.248-50D	387
		J.274	402
		J.306-50D	375
		J.306-50DRFID	876
		J.306-50DSLS	787
		J.306-50VSE	969
		J.306A100	375
		J.306A50	375
		J.306U	376
		J.306URFID	877
		J.360	302
		J.360-3P12	297
		J.360-3P6	297
		J.372	398
		J.372V	398
		J.373	398
		J.400	310
		J.400AVSE	966
		J.401	310
		J.401AVSE	966
		J.404	310
		J.405	310
		J.40E	310
		J.40U	310
		J.446-50	387
		J.8HLARFID	869
		J.8HRFID	869
		J.LAVSE	964
		J.9/16FRFID	871
		J.J11CFU	409
		J.J14CF	408
		J.J7RU	409
		J.J8FLU	409
		J.J9SPR	409
		JB	309
		JET.3WS	76
		JET.5GM3	58
		JET.5M3	58
		JET.6GM3	58
		JET.6GM3S	72

ALPHANUMERIC INDEX

JET.6GM4	61	JL.41E	310	JTX	311	M.230C	347
JET.6GM5	64	JLS2-1KEY	108	JX	311	M.230C1	347
JET.6M3	58	JLS2-2201	97	JXL.171	303	M.240SR	747
JET.6M4	61	JLS2-2MS13DH	115	K		M.SR	749
JET.6M5	64	JLS2-2MS13DL	113	K.120B	343	M.423E	349
JET.6MWB	66	JLS2-2MS7DH	114	K.120SR	747	M.431E	349
JET.7GM3	59	JLS2-2MS7DL	112	K.125A	343	M.431U	349
JET.7GM3EACC	71	JLS2-2MS7DSCH	116	K.126A	343	M.441E	349
JET.7GM4	62	JLS2-2MS7DSCL	114	K.140A	343	M.55SR	749
JET.7GM5	64	JLS2-2MW13DH	115	K.149	342	M.65B	348
JET.7M3	59	JLS2-2MW13DL	113	K.149SR	746	MAN	589
JET.7M4	62	JLS2-2MW7DH	114	K.B	345	MB-J15	1045
JET.7M5	64	JLS2-2MW7DL	111	K.151B	342	MB	1045
JET.8GM3	59	JLS2-2MW7DSCH	116	K.154AM	342	MB.H	1046
JET.8GM3EACC	71	JLS2-2MW7DSCL	112	K.154B	341	MB.H13	1046
JET.8GM3S	72	JLS2-A1000PP	101	K.SR	749	MB.MH	1045
JET.8GM4	62	JLS2-A1000PP.05	110	K.HB	345	MB.S	1045
JET.8GM5	65	JLS2-A1000PV	102	K.LA	346	MB.T45	1045
JET.8M3	59	JLS2-A500PP	101	K.PB	345	MC.130B	385
JET.8M4	62	JLS2-A500PP.03	109	K.DB	383	MC.270B	385
JET.8M5	65	JLS2-BASEMBD	95	K.200E	343	MOD.208	1125
JET.9GM3	59	JLS2-BASEMBS	95	K.208B	344	MOD.234	548
JET.9GM4	62	JLS2-CHD	99	K.210B	344	MOD.43	251
JET.9GM5	65	JLS2-CHDPP	100	K.210SR	747	MOD.44-1	225
JET.9M3	59	JLS2-CHS	99	K.214A	381	MOD.44-2	225
JET.9M4	62	JLS2-CHSPP	100	K.215B	344	MOD.440-1	221
JET.9M5	65	JLS2-LIGHT	108	K.230B	344	MOD.440-1XL	221
JET.A13XL	81	JLS2-LIGHTSUP	109	K.230B1	344	MOD.440-2	221
JET.A14M3	82	JLS2-MBD5T	91	K.232A	344	MOD.440-2XL	221
JET.A14M4	83	JLS2-MBD6T	91	K.240A	344	MOD.440-4	221
JET.A14M5	83	JLS2-MBDPP	93	K.240SR	747	MOD.467BFJ12	210
JET.A16	81	JLS2-MBDPP.06	110	K.306-1000D	375	MOD.467BJ12	204
JET.A17	81	JLS2-MBS.01	110	K.306-600D	375	MOD.467BJ13	204
JET.A18	80	JLS2-MBS2TV	92	K.306A1000	375	MOD.467BRJ12	207
JET.A1GXL	79	JLS2-MBS6T	90	K.382A	400	MOD.467BRJ14	207
JET.A2GXL	80	JLS2-MBS7T	90	K.383	400	MOD.467BXL	204
JET.A3	81	JLS2-MBSEN	94	K.500	1178	MOD.55-1	230
JET.A5-1GXL	79	JLS2-MBSPC	94	K.501	1178	MOD.55-2	230
JET.A5-2XL	79	JLS2-MBSPP	93	KL.161	341	MOD.55-3	230
JET.A5-3GXL	79	JLS2-MBSPP.04	110	KT.A	346	MOD.57LJ6	233
JET.A5GXL	79	JLS2-MBSPV	92	L		MOD.59LJ6	231
JET.A6M3	82	JLS2-MHDR	124	L.161	268	MOD.601	587
JET.A6M4	82	JLS2-MHDR	98	L.16AL	1058	MOD.64J7	211
JET.A6M5	82	JLS2-MHDR.06	110	L.16AM	1058	MOD.65J7	213
JET.A7GXL	82	JLS2-MHSPC	97	L.171	268	MOD.66A-1	249
JET.A8GXL	81	JLS2-MHSPP	96	L.21C	1058	MOD.66A-2	249
JET.A9M	83	JLS2-MHSPP.01	110	L.21L	1058	MOD.75-1	241
JET.A9XL	83	JLS2-MHSPV	96	L.21M	1058	MOD.84TZSA	453
JET.C4GM3	60	JLS2-MHTR	98	LAN-WRT1.2	771	MOD.89TXA	454
JET.C4GM4	63	JLS2-PAV1	102	LAN0.2	771	MOD.97	244
JET.C4GM5	66	JLS2-PAV2	102	LAN0.2TSL	769	MOD.99B	248
JET.C4M3	60	JLS2-PB1	104	LAN1.2	771	MOD.AT1	418
JET.C4M4	63	JLS2-PB2	104	LAN1.2M	771	MOD.AT1VE	430
JET.C4M5	66	JLS2-PB3	104	LAN1.2M	771	MOD.AT2	418
JET.CR4GM3	182	JLS2-PBA	104	LAN1.2M	771	MOD.AT3	418
JET.CR4M3	60	JLS2-PBAST	105	LAN1.2M	771	MOD.AT4	418
JET.T6GM3	67	JLS2-PBST1	105	LAN1.2M	771	MOD.AT5	418
JET.T6M3	67	JLS2-PBST2	105	LAN1.2M	771	MOD.AT6	418
JET.T7GM3	67	JLS2-PBST3	105	LIM200EM.J5	591	MOD.AT7	418
JET.T7M3	67	JLS2-PM1	106	LIM250EM.J5	591	MOD.ATX	418
JET2.15	84	JLS2-PM2	106	LT.01	255	MOD.ATXR	418
JET2.16	84	JLS2-PPAV1	103	M		MOD.BJ-GM	1061
JHX.14A	479	JLS2-PPAV1ELEC	103	M.HA	348	MOD.BJC	1061
JL.161	302	JLS2-PPAV2	103	M.120A	347	MOD.BRA	1061
JL.161-2P12	296	JLS2-PPAVA	103	M.120SR	747	MOD.BSB	1061
JL.161-2P12U	298	JLS2-PSB	106	M.125A	347	MOD.CAR2	1153
JL.161-2P6	296	JLS2-PSH	106	M.126A	347	MOD.CG	141
JL.161-3P12	297	JLS2-TC	109	M.151	346	MOD.CG1	141
JL.161-3P6	297	JLS2-TRAA2	107	M.151SR	746	MOD.CH	137
JL.161HLF	817	JLS2-TRAA3	107	M.200B	383	MOD.CPE5	140
JL.171	302	JLS2-TRAB2	107	M.200DB	383	MOD.CPEA0	522
JL.171-3P12	297	JLS2-TRAB3	107	M.200M	383	MOD.CPEA5	522
JL.171-3P6	297	JLS2-TRBB3	107	M.201B	383	MOD.DFD	1114
JL.171F	818	JLS2-TUBESUP400	108	M.210A	347	MOD.DFT	1117
JL.171RFID	866	JLS2-TUBESUP800	108	M.210SR	747	MOD.E20L	466
JL.171SLS	785	JLS2.02	110	M.215A	347	MOD.E41	466
JL.40E	310	JT	311			MOD.HLB	136
JL.40U	310	JT.AVSE	965			MOD.J161-212U	135

MOD.J161-36.....	134	MODM.AT6.....	418
MOD.J360-36.....	134	MODM.ATXR.....	418
MOD.JL161-212U.....	135	MODM.CG.....	153
MOD.JL161-36.....	134	MODM.CHA.....	149
MOD.JL171-36.....	134	MODM.CPE-R.....	835
MOD.LIM.....	590	MODM.CPE1SLS.....	795
MOD.MET.....	536	MODM.CPE2SLS.....	795
MOD.MI1.....	142	MODM.CPEA0.....	524
MOD.MI3.....	142	MODM.CPEA1.....	524
MOD.MI4.....	142	MODM.CPEA2.....	524
MOD.MI7.....	141	MODM.CPEA3.....	525
MOD.MT1.....	986	MODM.ENG-R.....	907
MOD.NS260.....	481	MODM.HLA.....	149
MOD.PC.....	523	MODM.J161-36.....	147
MOD.PCSN.....	523	MODM.JL161-36.....	147
MOD.PR11.....	523	MODM.JL1SLS.....	786
MOD.PR12.....	523	MODM.JL2U.....	907
MOD.PR4.....	522	MODM.MI1.....	152
MOD.PR8.....	522	MODM.MI1SLS.....	803
MOD.PR9.....	522	MODM.MI3.....	152
MOD.R161-16.....	133	MODM.MI4.....	152
MOD.R161-1U.....	276	MODM.MI5.....	153
MOD.R161-26.....	134	MODM.MI6.....	153
MOD.R161-66.....	133	MODM.MI7.....	153
MOD.S161-112U.....	136	MODM.PCSN.....	525
MOD.S161-212U.....	136	MODM.R161-36.....	147
MOD.S161-36.....	135	MODM.RL161-36.....	147
MOD.S161-46.....	135	MODM.RL1SLS.....	785
MOD.SHPA.....	137	MODM.RL1U.....	906
MOD.SL161-112U.....	136	MODM.RL2U.....	907
MOD.SL161-212U.....	136	MODM.ROUE.....	161
MOD.SL161-36.....	135	MODM.S161-212U.....	148
MOD.SL161-46.....	135	MODM.S161-36.....	149
MOD.TX1A.....	136	MODM.S1A.....	148
MOD.U306.....	631	MODM.SHP.....	149
MOD.U48A.....	1050	MODM.SL1.....	148
MOD.VEAO.....	522	MODM.SL171-36.....	148
MOD.Y105.....	731	MODM.SL1SLS.....	786
MODM.440-1.....	221	MODM.SL2U.....	907
MODM.440-2.....	221	MODM.SPL.....	908
MODM.440-4.....	905	MOUSQ8X80SLS.....	774
MODM.440J17SLS.....	780	MP.....	589
MODM.440J5SLS.....	780	MT.J.....	999
MODM.44J9SLS.....	782	MT.RS2.....	996

N

N.14-NPT-RFID.....	894
N.14-PT-RFID.....	894
N.18-NPT-RFID.....	894
N.38-NPT-RFID.....	894
N.38-PT-RFID.....	894
N.38A-10C.....	195
N.38A-12C.....	195
N.38A-4B.....	195
N.38A-6F.....	195
N.580.....	710
N.581.....	710
N.582.....	710
N.600.....	710
N.630.....	711
N.631.....	711
N.632.....	711
N.633.....	711
N.641.....	711
N.643.....	711
N.644.....	710
N.650.....	711
N.651.....	711
N.709.....	710
N.820.....	711
N.841.....	711
N.842.....	711
NEX.A.....	478
NG.A.....	363
NHX.14B.....	479
NJ.A.....	351
NJ.1300F2.....	682

NJ.1400F2.....	682
NJ.14S.....	913
NJ.2000F2.....	682
NJ.210A.....	351
NJ.211A.....	351
NJ.232A.....	351
NJ.236A.....	352
NJ.237A.....	352
NJ.240A.....	351
NJ.260.....	480
NJ.261M.....	480
NJ.262.....	480
NJ.3000F.....	682
NJ.A1700F2.....	687
NK.1000F2.....	682
NK.A.....	358
NK.LA.....	358
NK.2000F2.....	682
NK.210A.....	360
NK.215A.....	360
NK.218A.....	360
NK.230A.....	360
NK.232A.....	361
NK.240A.....	360
NK.3000F.....	682
NK.A.....	358
NK.LA.....	358
NK.500E.....	357
NK.500U.....	357
NKB.....	359
NKD.A.....	358
NKD.L.....	359
NKD.500.....	357
NKHM.....	359
NKTX.L.....	359
NKVR.....	360
NM.1000F2.....	690
NM.1010LF2.....	682
NM.209A.....	362
NM.210A.....	362
NM.215A.....	362
NM.A.....	361
NM.LA.....	361
NM.230A.....	362
NM.231A.....	362
NM.232A.....	363
NM.240A.....	362
NM.24A.....	361
NM.3000F.....	682
NM.3000LF.....	690
NM.3030LF.....	689
NM.ELA.....	362
NMB.....	362
NMD.65A.....	362
NP.B.....	385
NS.A.....	352
NS.LA.....	353
NS.1400F.....	682
NS.1600F.....	686
NS.210A.....	356
NS.215A.....	356
NS.219A.....	356
NS.230A.....	356
NS.232B.....	356
NS.236A.....	356
NS.237A.....	356
NS.240A.....	356
NS.2500G.....	686
NS.260A.....	481
NS.263M.....	481
NS.265M.....	481
NS.3100G.....	682
NS.3500G.....	682
NS.A1700F2.....	687
NS.MB.....	1127
NSB.....	353
NSD.B.....	353
NSD.L.....	354

NSHM.....	355
NSL.....	1126
NSI.EL.....	1126
NSX.....	354
NSTX.L.....	354
NSV.....	355
NSV.L.....	355
NSX.L.....	355
NSX.B.....	355

O

OD.80G.....	1043
-------------	------

P

P.27B.....	1047
PAM.B150A.....	592
PAM.B150EMA.....	592
PAM.B200A.....	592
PAM.B200EMA.....	592
PAM.B250A.....	592
PAM.B250EMA.....	592
PAM.B250EMASLS.....	796
PAM.MD150A.....	591
PAM.MD150EMA.....	591
PAM.MD200A.....	591
PAM.MD200EMA.....	591
PAM.MD200SR.....	756
PAM.MD250A.....	591
PAM.MD250EMA.....	591
PAM.MD250EMASLS.....	797
PAM.MD250SR.....	756
PAM.MD300SR.....	756
PCJ4.....	506
PCSNJ4.....	506
PL.400A.....	1151
PL.636.....	86
PL.655.....	87
PL.656.....	87
PL.656M4.....	87
PL.656M5.....	87
PL.L384.....	85
PL.M384.....	85
PL.S384.....	85
PM.384.....	85
PM.MOD3/3.....	85

R

R.....	290
R.CF.....	405
R.E.....	291
R.EF.....	816
R.EL.....	292
R.ELF.....	817
R.F.....	293
R.FLA.....	404
R.FLUO.....	816
R.HX.....	290
R.LA.....	291
R.LARFID.....	865
R.RFID.....	862
R.S.....	912
R.SEL.....	912
R.110.....	286
R.120A.....	285
R.AVSE.....	963
R.140A.....	285
R.150A.....	284
R.151-1P6.....	273
R.151B.....	283
R.161-1P6U.....	275
R.161-2P6.....	273
R.161-2P6U.....	275
R.161-3P6.....	273
R.161-3P6U.....	275
R.161-4P12U.....	276

ALPHANUMERIC INDEX

R.161-4P6.....	274	R.400U.....	293	RL.NANO-U2.....	272	S.208RFID.....	872
R.161-4P6U.....	276	R.401.....	293	RL.NANO1.....	271	S.208S.....	330
R.161-5P12.....	274	R.401U.....	293	RL.NANO112.....	271	S.208SR.....	747
R.161-5P6.....	274	R.404.....	293	ROLL.6GM3.....	70	S.210.....	329
R.161-5P6U.....	276	R.404U.....	293	ROLL.6M3.....	70	S.210AVSE.....	968
R.161-6M6.....	274	R.405.....	293	ROLL.C4M3.....	70	S.210RC.....	330
R.161-6P6.....	274	R.40U.....	292	ROLL.CR4M3.....	70	S.210RCRFID.....	871
R.161-6P6HX.....	290	R.446-25.....	387	ROLL.UC3S.....	76	S.210S.....	330
R.161B.....	283	R.HX.....	290	RSX.19A.....	1136	S.210SR.....	747
R.180.....	267	R.ELRFID.....	864	RSX.19B.....	294	S.212SR.....	747
R.180HX.....	267	R.ERFID.....	863	RT.....	294	S.215.....	329
R.180J31.....	267	R.FLUO.....	815	RT.AVSE.....	963	S.215AVSE.....	968
R.200P.....	402	R.J6CFU.....	408	RTX.....	293	S.215RC.....	330
R.203A.....	381	R.J8CF.....	408	RX.....	294	S.215RCRFID.....	871
R.203DA.....	381	R.PE.....	267	RPICO.....	267	S.215S.....	330
R.205E.....	382	R.PEJ31.....	267			S.215SR.....	747
R.208-25.....	380	R1PICO.....	267	S		S.217.....	329
R.209.....	286	R2NANO.....	271	S.....		S.217RC.....	330
R.209RFID.....	861	RAB.DRDB250A.....	596	S.AVSE.....	332	S.217RCRFID.....	871
R.209S.....	287	RAB.DRDB300EMA.....	596	S.H.....	966	S.21AVSE.....	966
R.210.....	286	RAB.DRDMD250A.....	596	S.HRFID.....	332	S.228.....	329
R.210AVSE.....	964	RAB.DRDMD250EMA.....	596	S.LA.....	873	S.229A.....	329
R.210RC.....	287	RAB.DRDMD300A.....	596	S.LA.....	333	S.22AVSE.....	966
R.210RCF.....	814	RAB.DRDMD300EMA.....	596	S.LARFID.....	875	S.230.....	331
R.210RCRFID.....	861	RAB.PB250A.....	597	S.RFID.....	874	S.230RFID.....	872
R.210S.....	287	RAB.PMD250A.....	597	S.SR.....	748	S.231.....	331
R.215.....	286	RAB.RD250A.....	597	S.110.....	329	S.232B.....	331
R.215RC.....	287	RAB.RD250EMA.....	597	S.120A.....	328	S.234.....	331
R.215RCF.....	814	RB.....	291	S.HLA.....	333	S.236.....	331
R.215RCRFID.....	861	RB.161-4P12U.....	276	S.HLARFID.....	873	S.237.....	331
R.216.....	287	RB.40AE.....	292	S.LAVSE.....	967	S.240A.....	330
R.217.....	286	RB.40AU.....	292	S.141A.....	328	S.240ARFID.....	872
R.217RC.....	287	RD.B150A.....	594	S.145.....	328	S.240SR.....	747
R.217RCF.....	814	RD.B150EMA.....	594	S.151-1P12.....	314	S.248-D.....	387
R.217RCRFID.....	861	RD.B200A.....	594	S.151-1P6.....	314	S.25H.....	332
R.222B.....	286	RD.B200EMA.....	594	S.151-2P12.....	314	S.284.....	402
R.227A.....	286	RD.B250A.....	594	S.151-2P6.....	314	S.305P.....	403
R.227AF.....	815	RD.B250EMA.....	594	S.151, S.151B, S.154.....	325	S.305PRFID.....	877
R.228.....	288	RD.MD150A.....	593	S.151B.....	327	S.306-100D.....	375
R.229A.....	288	RD.MD150EMA.....	593	S.151B-KIT.....	325	S.306-100DRFID.....	876
R.232.....	288	RD.MD150SR.....	756	S.152.....	402	S.306-100DSLS.....	787
R.232F.....	815	RD.MD200A.....	593	S.154.....	327	S.306-100R.....	376
R.235.....	289	RD.MD200EMA.....	593	S.155SR.....	746	S.306-200D.....	375
R.235F.....	815	RD.MD200EMASLS.....	797	S.156.....	328	S.306-200DRFID.....	876
R.236A.....	285	RD.MD200SR.....	756	S.161-1P12U.....	316	S.306-200DSLS.....	787
R.236AF.....	814	RD.MD250A.....	593	S.161-1P6U.....	316	S.306-200R.....	376
R.236AFRFID.....	860	RD.MD250EMA.....	593	S.161-2P12.....	314	S.306-350D.....	375
R.236C.....	286	RD.MD250SR.....	756	S.161-2P12U.....	316	S.306-350DRFID.....	876
R.236CF.....	814	RD.MD300SR.....	756	S.161-2P6.....	314	S.306-350DSLS.....	787
R.240A.....	288	REL.40.....	292	S.161-2P6U.....	316	S.306-350R.....	376
R.240ARFID.....	861	REL.40U.....	292	S.161-3P12.....	314	S.306A100.....	375
R.245.....	289	REL.40UF.....	816	S.161-3P12U.....	316	S.306A200.....	375
R.248-25D.....	387	REL.41.....	292	S.161-3P6.....	314	S.306A350.....	375
R.301A.....	375	RL.161.....	282	S.161-3P6U.....	316	S.306U.....	376
R.304DA.....	375	RL.161-1P6.....	273	S.161-4P12.....	315	S.360.....	326
R.304DARFID.....	876	RL.161-1P6U.....	275	S.161-4P6.....	315	S.360-3P12.....	314
R.306-25D.....	375	RL.161-2P6.....	273	S.161-5P12.....	315	S.360-3P6.....	314
R.306-25DRFID.....	876	RL.161-3P6.....	273	S.161-5P6.....	315	S.360-4P12.....	315
R.306-25DSLS.....	787	RL.161-3P6U.....	275	S.161B.....	326	S.360-4P6.....	315
R.306-5.....	376	RL.161-4P12U.....	276	S.161B-KIT.....	325	S.372.....	398
R.306-5RFID.....	876	RL.161-4P6.....	274	S.200P.....	402	S.372V.....	398
R.306A25.....	375	RL.161-4P6U.....	276	S.202A.....	382	S.373.....	398
R.306U.....	376	RL.161-5P12.....	274	S.203A.....	381	S.382.....	400
R.306URFID.....	877	RL.161-5P6.....	274	S.203DA.....	381	S.382V.....	400
R.344DA.....	387	RL.161-5P6U.....	276	S.203E.....	402	S.383.....	400
R.360.....	282	RL.161-6P6.....	274	S.205E.....	382	S.400AVSE.....	968
R.360-1P6U.....	275	RL.161HLF.....	812	S.206.....	329	S.401AVSE.....	968
R.360-2P6.....	273	RL.171.....	282	S.206RFID.....	872	S.40E.....	324
R.360-4P6.....	274	RL.171-1P6U.....	275	S.208.....	329	S.40U.....	324
R.360F.....	813	RL.171-2P6.....	273	S.208-100.....	380	S.41E.....	324
R.360NANO.....	271	RL.171-4P6.....	274	S.208-100D.....	380	S.41U.....	324
R.360NANO-U1.....	272	RL.171F.....	813	S.208-200.....	380	S.446-100.....	387
R.360NANO-U112.....	272	RL.171RFID.....	860	S.208-200D.....	380	SE.1A.....	1092
R.360RFID.....	860	RL.171SLS.....	785	S.208-340.....	380	SH-BAG1SLS.....	769
R.372.....	398	RL.40E.....	292	S.208-340D.....	380	SH-SLS.....	768
R.373.....	398	RL.41E.....	292	S.208A100.....	380	SH-SUPSLS.....	769
R.400.....	293	RL.NANO-U1.....	272	S.208A200.....	380	SHPLA.....	335
R.400AVSE.....	964	RL.NANO-U112.....	272	S.208A340.....	380	SHP.5ELA.....	335

SHP.6EL1A.....	335	U.14L.....	643
SHP.6EL2A.....	335	U.16A18.....	1129
SJ.214.....	381	U.16A45.....	1129
SJ.235.....	474	U.16B.....	1129
SJ.236.....	474	U.16B32.....	1129
SL.161.....	326	U.179A.....	1125
SL.161-1P12U.....	316	U.18-36.....	1187
SL.161-1P6U.....	316	U.18H36.....	1187
SL.161-2P12.....	314	U.2.....	652
SL.161-2P12U.....	316	U.20.....	633
SL.161-2P6.....	314	U.20B.....	633
SL.161-2P6U.....	316	U.232.....	643
SL.161-3P12.....	314	U.23D.....	648
SL.161-3P6.....	314	U.23J1A.....	647
SL.161-3P6U.....	316	U.23J2.....	647
SL.161-4P12.....	315	U.23J3.....	647
SL.161-4P6.....	315	U.23K1A.....	655
SL.161-5P12.....	315	U.23K1A-03.....	656
SL.161-5P6.....	315	U.27AS3.....	634
SL.161HLF.....	819	U.27B.....	635
SL.171.....	326	U.27D.....	634
SL.171-3P12.....	314	U.28.....	649
SL.171-3P6.....	314	U.28J1.....	649
SL.171-4P12.....	315	U.2A.....	652
SL.171-4P6.....	315	U.3.....	639
SL.171RFID.....	871	U.30.....	649
SL.171SLS.....	786	U.301.....	643
SL.DBOX1.....	1151	U.301BJ1.....	658
SLS.G.....	776	U.301E1.....	651
SLS.GKIT1.....	777	U.301E2.....	651
SLS.GKIT1-GUN.....	777	U.301L.....	645
ST.....	334	U.301M.....	644
ST.AVSE.....	967	U.301P.....	645
STG.....	590	U.302.....	632
STM.....	334	U.306-N.....	630
STU.....	590	U.306.....	630
STX.....	334	U.306A130N.....	630
SV.B.....	335	U.306A140.....	630
SV.ELB.....	335	U.306J1.....	631
SV.LB.....	335	U.306M.....	652
SV.J5.....	1092	U.310.....	631
SV.J7A.....	336	U.310-230N.....	632
SV.J8B.....	336	U.312-01.....	639
SV.LJ6B.....	336	U.312G.....	637
SVL.J7A.....	336	U.312HJ3.....	637
SX.LA.....	335	U.312HJ4.....	637
SXL.....	268	U.320.....	635
SXL.161.....	327	U.320H.....	638
SXL.161-4P12.....	315	U.32T15.....	641
SXL.161-4P6.....	315	U.32T15GA.....	642
SXL.171.....	327	U.32T2.....	641
SXL.180.....	328	U.32T2GA.....	642
SXM.....	335	U.32T6.....	641
		U.32T6GA.....	642
		U.330.....	635
		U.330H.....	638
		U.33A.....	640
		U.34.....	645
		U.35.....	645
		U.35L.....	645
		U.35P.....	645
		U.40.....	649
		U.42.....	646
		U.42B.....	644
		U.43.....	1089
		U.43-ORG.....	1092
		U.43LA.....	1089
		U.43LA16A.....	1089
		U.46.....	1051
		U.46ACL.....	1048
		U.46PL.....	1051
		U.48.....	1050
		U.48PL.....	1050
		U.49AM.....	652
		U.49BR1.....	651
		U.49L.....	652
		U.49P.....	650
		U.49PJ1.....	650

U.49PJ2.....	650	U.9-01A.....	1131
U.49PJ3.....	651	U.9-03.....	1131
U.49PJ4.....	651	U.J2.....	657
U.51B.....	648	U.JA1.....	657
U.52.....	646	U.JA3.....	657
U.53E.....	656	UCB12A.....	1069
U.53H.....	656	UWG.320.....	639
U.53J1.....	653	UWG.320H01.....	639
U.53J2.....	654	UWG.330.....	639
U.53K.....	655	UWG.330H01.....	639
U.53KL0.....	655	UWP.10MA.....	639
U.53KL0-02.....	656		
U.53KL2.....	655		
U.53RL.....	656		
U.53R4LA.....	656		
U.53S2A.....	655		
U.53S4A.....	655		
U.53T.....	654		
U.54A.....	1090		
U.66A.....	640		
U.7-3545.....	1130		
U.89JMA.....	1122		
U.89M.....	1121		
U.89M2.....	1122		
U.89M20.....	1121		
U.89M230.....	1122		
U.89M2JM.....	1122		
U.89M30.....	1121		
U.9-01A.....	1131		
U.9-03.....	1131		
U.J2.....	657		
U.JA1.....	657		
U.JA3.....	657		
UCB12A.....	1069		
UWG.320.....	639		
UWG.320H01.....	639		
UWG.330.....	639		
UWG.330H01.....	639		
UWP.10MA.....	639		

■ V

V.103MF.....	694	V.321AH.....	705
V.252F.....	696	V.331AH.....	704
V.254F.....	696	V.336AH.....	704
V.256F.....	696	V.345F.....	700
V.258F.....	696	V.347F.....	702
V.260F.....	696	V.352F.....	709
V.320FH.....	705	V.401F.....	697
V.321AH.....	705	V.402F.....	699
V.331AH.....	704	V.403F.....	699
V.336AH.....	704	V.410F.....	697
V.345F.....	700	V.411F.....	697
V.347F.....	702	V.445F.....	700
V.352F.....	709	V.462F.....	703
V.401F.....	697	V.472F.....	703
V.402F.....	699	V.500F.....	698
V.403F.....	699	V.582F.....	702
V.410F.....	697	V.610RF.....	694
V.411F.....	697	V.620RF.....	694
V.445F.....	700	V.770F.....	706
V.462F.....	703	V.775F.....	706
V.472F.....	703	V.781F.....	708
V.500F.....	698	V.801F.....	708
V.582F.....	702	V.820F.....	709
V.610RF.....	694	V.850F.....	706
V.620RF.....	694	V.902F.....	704
V.770F.....	706	V.97F.....	694
V.775F.....	706	V.999A.....	710
V.781F.....	708	V.AG50F.....	703
V.801F.....	708	V.CA50F.....	703
V.820F.....	709		
V.850F.....	706		
V.902F.....	704		
V.97F.....	694		
V.999A.....	710		
V.AG50F.....	703		
V.CA50F.....	703		

V.D100QR.....	695	VH30.200SR.....	759
V.D130KR.....	695	VH40.300SR.....	759
V.D600QR.....	695	VH50.400SR.....	759
V.DA100KR.....	695	VH60.500SR.....	759
V.DG300F.....	700	VH80.700SR.....	759
V.DG500F.....	699	VM.600.....	702
V.DG515F.....	700	VM.604.....	702
V.DGA305F.....	701	VM.606.....	702
V.DGA310F.....	701	VM.610.....	702
V.DGA505F.....	701	VM.612.....	702
V.DGE300F.....	699	VM.624.....	702
V.PF300F.....	709	VR.154.....	693
VE.A3.....	521	VR.J254.....	692
VF.1200.....	606	VR.J3108.....	693
VF.1202.....	606	VR.JZ300F2.....	692
VF.1210.....	606	VR.R127.....	693
VFA.1200.....	606	VR.R227.....	692
VFA.1202.....	606	VR.S3136.....	693
VFA.1204.....	606	VR.SZ300F2.....	691
VFA.1206.....	606		
VFA.1208.....	606		
VFA.1210.....	606		
VFA.600.....	606		
VFA.602.....	606		
VFA.604.....	606		
VFA.606.....	606		
VFA.608.....	606		
VFA.610.....	606		
VH30.200SR.....	759		
VH40.300SR.....	759		
VH50.400SR.....	759		
VH60.500SR.....	759		
VH80.700SR.....	759		
VM.600.....	702		
VM.604.....	702		
VM.606.....	702		
VM.610.....	702		
VM.612.....	702		
VM.624.....	702		
VR.154.....	693		
VR.J254.....	692		
VR.J3108.....	693		
VR.JZ300F2.....	692		
VR.R127.....	693		
VR.R227.....	692		
VR.S3136.....	693		
VR.SZ300F2.....	691		

■ W

W.415WBA.....	1030	WRT-DSLS.....	769
W.420.....	1030	WRT-SHSLs.....	768
W.430.....	1031		
W.450.....	1031		
W.PROTECT20.....	1032		
W.PROTECT30.....	1032		
W.PROTECT50.....	1032		
W.PROTECT.....	1032		
W.PROTECT1.....	1032		
W.PUNCHES-A.....	1032		
WB.1500GSA.....	120		
WB.1500WA.....	121		
WB.2000GSA.....	120		
WB.2000WA.....	121		
WB.DRAWER.....	121		
WF135.50SR.....	755		
WF150.30SR.....	755		
WF150.40SR.....	755		
WF180.32SR.....	755		
WF180.50SR.....	755		
WF200.20SR.....	755		
WF200.40SR.....	755		
WF230.40SR.....	755		
WF250.40SR.....	755		
WF80.13SR.....	755		
WRT-DSLS.....	769		
WRT-SHSLs.....	768		

ALPHANUMERIC INDEX

■ Y							
Y.103B.....	732	136A.....	725	183AE.20CPE.....	489	195A.CPE.....	489
Y.104.....	732	136A.SR.....	759	185.20AVSE.....	959	195A.G.....	492
Y.107.....	733	136C.4.....	725	185.20CPEF-R.....	834	195A.VE.....	497
Y.113B.....	733	137A.....	759	185.20CPEFID.....	887	196.KS.....	1116
Y.116B.....	732	137A.SR.....	759	185.20CPESLS.....	792	196.TS.....	1116
Y.135F.....	733	137B.....	725	185.20VERFID.....	892	197A.....	506
Y.M46.....	731	138.S.....	726	185.L.....	518	197A.RFID.....	891
Y.RIV1.....	731	138A.....	726	185A.20CPE.....	489	197A.18F.....	840
Y.RIV3.....	731	139.....	1004	185A.20G.....	492	199A.....	505
		14.....	403	185A.20VE.....	497	199A.18F.....	840
		140.AA.....	1001	186.SR.....	753	199A.RFID.....	891
		140.AAW13.....	1001	187.AVSE.....	958	20.....	403
		141.....	1003	187.16CPEF.....	832	2000.ROLL6M3W.....	117
		142.....	1003	187.16CPEF-R.....	834	200C.....	561
10.....	399	143.....	1003	187.16CPEFID.....	888	200C.F.....	843
10.J11.....	406	144.....	1003	187.CPESLS.....	793	200C.SLS.....	800
10.J9U.....	406	145.....	1004	187.SR.....	753	200H.....	563
1003B.68E.....	1014	146.Y.....	1002	187.18CPEF-R.....	834	200H.RFID.....	883
1003B.E.....	1013	147.J7.....	1005	187.18CPEFID.....	888	202H.....	564
101.....	257	148.....	1001	187.18VERFID.....	893	202H.SR.....	754
101.G.....	257	149.....	1001	187A.CPE.....	490	203H.....	565
101.GR.....	257	149.Y.....	1002	187A.16G.....	492	204.....	566
105.....	259	150.....	1001	187A.VE.....	497	205C.....	561
1075.H.....	1017	150.P.....	1004	187A.G.....	492	205C.SLS.....	800
11.....	401	151.....	1001	187AP.20CPE.....	490	205H.....	563
11.J11.....	406	151B.....	268	188.16AVSE.....	958	205H.RFID.....	883
11.J8U.....	407	152.....	1001	188.CPEF.....	833	207A.....	569
1116C.BW.....	1015	152.Y.....	1002	188.CPERFID.....	888	207A.CB.....	568
113.TAVSE.....	962	153.....	1002	188.20VERFID.....	893	207A.CBSLS.....	801
1130.1.....	1016	154.....	1002	1885.00.....	546	208A.A.....	569
113A.C.....	258	156.....	1004	188A.CPE.....	490	208A.CBA.....	568
113A.CRFID.....	859	160A.....	244	188A.G.....	493	208A.BBA.....	568
113A.SR.....	746	161B.....	268	188A.VE.....	498	208A.CBASLS.....	801
113A.T.....	259	163.....	931	188A.20VE.....	953	208A.CCA.....	568
113AS.C.....	258	165.1.....	930	188AC.16CPE.....	490	209.50.....	1152
1150.MT.....	1007	167A.....	506	189.17AVSE.....	959	2092B.....	181
115A.....	253	169A.....	505	189.17CPEF.....	833	212A.....	567
116.....	254	170.FIL.....	1185	189A.17CPE.....	490	212A.F.....	843
117.B.....	255	170A.....	502	189A.17VE.....	498	212A.SLS.....	800
117.E.....	255	171.20EL.....	519	190.16AVSE.....	958	213H.....	565
118.EC.....	255	173A.....	931	190.CPEF.....	831	214.....	570
118A.....	255	177A.....	505	190.CPERFID.....	887	214.R.....	570
119.....	254	177A.RFID.....	891	190.CPESLS.....	791	215H.....	565
12.....	399	177A.SLS.....	793	190A.CPE.....	487	216.....	567
12.J11.....	407	177A.F.....	840	190A.G.....	491	217.....	1087
12.J9U.....	407	179A.....	504	190A.16VE.....	496	217.GJ1.....	571
1200.50.....	538	179A.RFID.....	891	191A.22EL.....	519	217.J2.....	1087
1202.....	538	179A.SLS.....	793	192.AVSE.....	957	217.R12.....	571
1202.00.....	538	179A.F.....	840	192.CPEF.....	831	22.....	226
120A.....	725	180.....	501	192.CPEF-R.....	834	22.JE6T.....	227
120A.SR.....	758	180.CPE.....	501	192.CPERFID.....	886	2202XL.....	125
121A.....	725	180.CPEF.....	830	192.CPESLS.....	791	221.....	599
1224.....	736	180.CPERFID.....	886	192.SR.....	752	221.227J1.....	600
1224.E.....	736	180.CPESLS.....	791	192A.CPE.....	487	221.227J2.....	600
122A.SR.....	758	180.VE.....	501	192A.G.....	491	221.227SJ1.....	600
1230B.....	1014	180.VERFID.....	892	192A.VE.....	495	221.227SJ2.....	600
125A.....	253	180.VSE.....	957	192T.18UPE.....	485	221.....	599
126.E.....	254	1802A.N.....	1012	193.16AVSE.....	959	2225.A1.....	84
1260.....	722	1802A.R.....	1012	193.16CPEF.....	832	222A.T.....	602
1261H.SR.....	754	1803A.N.....	1012	193.16CPEFID.....	888	222A.TJ19.....	602
1262H.100.....	566	1803A.R.....	1012	193.16VERFID.....	893	222A.TJ25.....	602
1262H.SR.....	754	1804B.N.....	1012	193.20G.....	518	222A.TJ32.....	603
1262H.....	566	1804B.R.....	1012	193A.16CPE.....	489	222A.TJ50.....	602
1263H.400.....	566	1813.....	1005	193A.16G.....	492	222A.TJ81.....	602
126A.....	254	1817.....	1006	193A.16VE.....	497	223.SJ7.....	604
13.....	401	181A.CPE.....	500	194.12.....	494	2235.AT2.....	120
13.J10.....	407	181A.CPEF.....	830	194.17AVSE.....	959	2235.AT3.....	120
13.J8U.....	408	181A.CPERFID.....	886	194.17VERFID.....	893	2245.....	119
1300EA.....	531	181A.CPESLS.....	790	194A.17CPE.....	491	2245.PVAT3.....	119
131A.....	724	181A.18G.....	500	194A.17VE.....	498	225.J3.....	1151
131A.SLS.....	784	181A.G.....	500	195.16CPEF.....	831	2250.....	118
1320.....	531	181EF.25CPE.....	500	195.16CPEF-R.....	835	2250.AT3.....	118
133A.....	724	181EF.25G.....	500	195.CPERFID.....	888	227.T2.....	598
134A.SR.....	759	1820.AVSE.....	961	195.CPESLS.....	792	227.T3.....	598
1350.....	532	183.20CPEF.....	832	195.20AVSE.....	959	227.J1.....	600
1355A.....	532	183.20CPEF-R.....	835	195.20CPEF.....	831	227.J2A.....	600
135A.....	724	1830.....	1008	195.20VERFID.....	892	227.ST2.....	599
1365.....	532	183A.20CPE.....	489	195.34L.....	518	227.ST3.....	599

SEARCH BY PRODUCT REFERENCE NUMBER

227.SJ1.....	600	2702.....	77
227.SJ2A.....	600	2702.TAB.....	77
229.TT.....	606	2703.....	77
229.TTJ4.....	606	270A.MA.....	721
229A.....	603	271A.....	737
229A.J3.....	604	271A.150L.....	737
229A.ST.....	603	271A.80S.....	737
230.....	1140	272.L.....	738
230.J1.....	1140	272A.....	738
231.....	606	274.....	739
232.....	607	275.....	739
234.....	548	276.....	1060
234.SSLS.....	795	285.....	660
234A.S.....	548	285.F.....	660
234F.....	842	285.J10.....	659
235.J1.....	607	285.JS10.....	659
236.....	549	285.JS5.....	659
237.....	600	286A.....	661
237.J1.....	607	286A.PL.....	661
238B.16.....	728	287B.....	661
239.....	730	287B.JS5.....	662
240.M.....	730	289.J1.....	662
242.....	730	289.M.....	662
245A.M.....	623	292A.....	549
245A.P1.....	623	2930.B.....	124
245A.T.....	623	2930.C.....	123
246.....	576	2936B.....	122
246.JS6.....	576	2937B.....	122
246.JT6.....	576	2938B.....	123
247.....	577	2939B.....	123
247.249JS12.....	576	293A.....	549
247.265JT10.....	576	307B.....	555
247.G.....	572	307BM.....	554
247.GSLS.....	802	31.....	226
248.....	575	31.JE6T.....	226
248.JS6.....	576	31.JE8T.....	226
248.JT7.....	576	311B.....	555
249.....	575	325.....	729
249.F.....	844	329.....	607
249.RFID.....	882	333C.67.....	728
249.SR.....	755	333C.67M.....	728
249.G.....	572	333C.67NX.....	727
249.G247GJ12.....	573	334C.35.....	728
249.SLS.....	801	334C.35NX.....	727
249.GJ.....	573	335.25.....	728
249.JS7.....	576	335.63.....	729
249.JT7.....	576	335B.40.....	729
251A.....	576	337A.2.....	727
251A.JS9.....	576	338B.1.....	727
251A.JT9.....	576	34.....	227
255.G.....	573	34.F.....	810
255.GSLS.....	802	34.JL16T.....	227
255.G8.....	573	34.JU13T.....	227
256.....	577	344B.....	726
256.F.....	844	347.....	730
256.RFID.....	882	360.....	268
257.G.....	574	372.....	1007
257A.....	577	373.....	735
259.....	1138	376A.....	734
259.P.....	578	377B.....	734
259SLS.....	803	378A.50.....	734
260.P.....	579	379A.....	735
2600.A2.....	84	380.....	735
2600.M.....	84	39.....	221
262A.....	579	39.F.....	809
262A.JS4.....	579	39.H.....	221
263.....	578	39.HF.....	809
263.265JS5.....	579	39.RFID.....	853
263.SR.....	755	39.HRFID.....	853
263.G.....	574	39.JE10.....	222
263.GSLS.....	802	39.JE10T.....	222
263.GJ4.....	575	39.JE16T.....	222
263.P.....	578	39.JE9T.....	222
265.....	579	39.JP6.....	222
265.SR.....	755	39.JU10T.....	222
265.G18.....	574	39.JU14T.....	222
268.3.....	722	391.16AVSE.....	958
269.....	722	391.16CPRFID.....	887

ALPHANUMERIC INDEX

391.16VERFID.....	892	421.MT.....	982
391A.CPE.....	487	421.MTF.....	838
391A.G.....	491	421.MTFRFID.....	889
391A.VE.....	496	422.MT.....	984
395.....	517	422.MTF.....	837
396.....	517	422.MTFRFID.....	889
3067.200.....	554	423.MT.....	985
3067.300.....	554	423.MTF.....	837
3071.200.....	553	423.MTFRFID.....	890
40.LA.....	223	424.MT.....	986
401.....	494	425.....	493
401.MT.....	982	425.E.....	988
402.....	494	425.MT.....	979
402.MT.....	984	425F.....	839
403.....	494	425FRFID.....	889
403.MT.....	985	426.E.....	988
405.....	493	426.MT.....	979
405.10E.....	988	427.E.....	990
405.10MT.....	978	427.MT.....	981
405.10MTFRFID.....	889	429.E.....	990
405.10RE.....	988	429.MT.....	981
405.10RMT.....	978	43.....	251
405.10RMTF.....	836	43.JE5T.....	251
405.12.....	493	431.E.....	991
405.12E.....	989	431.LE.....	991
405.12F.....	839	431.LMT.....	983
405.12MT.....	979	431.LMTF.....	838
405.12MTFRFID.....	889	431.LMTFRFID.....	890
405.8E.....	987	431.MT.....	983
405.8MT.....	978	432.E.....	992
405.E.....	988	432.LE.....	992
405.MT.....	978	432.LMT.....	985
405A.15.....	493	432.MT.....	984
406.8E.....	987	433.LE.....	992
406.8MT.....	978	433.LMT.....	986
406.E.....	988	433.LMTF.....	837
406.MT.....	978	433.LMTFRFID.....	890
406.RMT.....	978	435.....	493
406.RMTF.....	836	435.E.....	988
407.8E.....	987	435.MT.....	979
407.8MT.....	978	435.RE.....	988
407.E.....	988	44.....	224
407.MT.....	978	44.F.....	811
40LA.JE17.....	223	44.SLS.....	782
41.....	222	44.JE.....	225
41.JE12T.....	223	44.JU.....	225
41.JE18.....	223	44.P16E.....	225
41.P24M.....	223	440.....	219
410.....	519	440.RFID.....	852
410.S.....	519	440.SLS.....	779
410.SF.....	841	440.SR.....	743
411A.....	509	440.H.....	219
412.AVSE.....	960	440.HRFID.....	852
412.....	612	440.JE.....	220
412B.10.....	612	440.JN.....	220
413.52.....	612	440.JP.....	220
413A.32.....	612	440.JP9.....	1151
414.45AVSE.....	960	440.JU.....	220
415.E.....	989	440.P25M.....	220
415.MT.....	979	442.....	494
416.....	493	445.DS.....	921
416.12E.....	990	445.DSF.....	841
416.MT.....	980	445.R.....	510
416.E.....	989	445.RRFID.....	894
416.PE.....	989	449.Z1B.....	1074
416.PMT.....	980	449.Z3A.....	939
416.RMT.....	980	449B.....	935
416.RMTF.....	836	449BF.....	840
417.PE.....	989	449BFRFID.....	894
417.PMT.....	980	449BSLS.....	794
417.SPE.....	991	45.....	228
417.SPMT.....	982	455B.....	940
418.MT.....	981	455BSLS.....	794
42.....	252	46.AVSE.....	961
42.JE5T.....	252	464.J1.....	216
420.E.....	991	464.M14X19.....	215
420.MT.....	983	464.MKIT.....	215
421.....	494	464TX.....	217

ALPHANUMERIC INDEX

464TX.J3.....	217	55A.JN.....	230	697653.....	946	804.LF.....	842
464TX.J4.....	217	55A.JU10.....	230	701B.....	949	804.P.....	1059
467.....	509	55A.P14E.....	230	703232.....	177	804.U.....	1059
467.01AJ2.....	509	56A.....	232	705.....	1064	804F.....	842
467.RFID.....	854	56L.....	232	70A.....	250	804FSLs.....	796
467.SLS.....	780	57.....	235	70A.JE5T.....	250	805.....	533
467.ADAPT10-19.....	213	57.JE5.....	235	70A.JN6.....	250	805.M.....	533
467.ADAPT10MM.....	213	57L.....	233	711A.....	948	805.S.....	534
467B.....	203	57L.SPL.....	911	712A.....	948	806.C25.....	535
467B.J7.....	204	580.....	513	714A.....	1063	806.F.....	535
467B.JP.....	204	582.7.....	514	715.....	1063	806C.....	535
467BF.....	210	59.....	234	720.P1500.....	948	807C.....	535
467BF.JP.....	210	59.JE12.....	234	740A.....	1033	809.....	541
467BR.....	206	59.JN.....	234	74A.....	245	809.IN500.....	541
467BR.J7.....	206	599.....	585	74A.F.....	812	809.ING500.....	541
467BR.JP10.....	207	599SR.....	757	74A.JL14.....	245	809.J2.....	536
467BS.....	208	59L.....	231	74A.JL9.....	245	809.J3.....	536
467BS.BOX.....	209	59TX.....	234	74A.P14E.....	245	811B.....	534
467BS.JP.....	208	59TX.J4.....	234	74T.....	246	811C.250.....	534
467F.RFID.....	855	601.....	585	75.....	240	812.3.....	537
467FLUO.....	841	601SLS.....	796	75.SR.....	744	812A.....	537
467S.SLS.....	781	602.AVSE.....	960	75.RFID.....	858	812B.AC.....	537
469.....	509	603F.....	584	75.J12.....	241	812B.P.....	537
469F.....	841	603FRFID.....	884	75.JE16.....	241	813B.S.....	546
470.....	508	605.B.....	586	75.JN10.....	241	814.G.....	539
470.E.....	509	606A.....	586	75.JN8.....	241	814.M.....	539
470.MT.....	1005	607.MT.....	1006	75.JU10.....	241	814.NI.....	539
475A.....	508	608.L12.....	1006	75.P22M.....	241	814.WH.....	539
475A.J1.....	508	609A.....	605	750.KB.....	1095	816.....	534
477.32.....	507	609A.J1.....	605	750.TB.....	1095	817.....	545
479.32.....	507	609A.J3.....	605	751.K.....	1095	818.CLO.....	543
481.40.....	503	629731.....	942	751.T.....	1095	818B.....	543
482.SR.....	752	629757.....	942	76.....	242	819.CLO.....	543
484A.....	502	629765.....	943	76.RFID.....	858	819810.....	933
484A.30.....	502	629773.....	943	76.SLS.....	784	819832.....	932
485.....	503	629781.....	944	76.JE16.....	242	819B.15.....	544
49.SR.....	746	629853.....	943	76.JN.....	242	821416.....	932
490.SE.....	507	629861.....	943	76.P22M.....	242	823.25.....	547
495A.EL.....	517	629888.....	944	777.SPOT.....	677	826.....	923
497.32.....	507	629896.....	943	777.SPOTBT.....	677	827.....	923
499.32.....	507	629909.....	944	777A.F.....	679	827.M.....	1009
50.SR.....	745	629984.....	944	777B.F.....	679	827B.....	1009
50.SH.....	239	64.....	211	778A.....	1087	828.....	923
500A.....	512	64.F.....	810	779.CBT.....	675	829.....	922
500ASLS.....	794	64.RFID.....	856	779.CL4.....	669	829AR.....	922
501.....	1151	64.J4.....	211	779.CML.....	673	82H.....	450
501A.....	512	64.JE6T.....	211	779.CRT.....	675	82H.SR.....	751
501AMP.....	512	64.JU6T.....	211	779.EYE.....	677	82H.JE10.....	444
501ASLS.....	794	640171.....	940	779.FRT2.....	671	82H.JL.....	444
502A.....	515	640180.....	621	779.MAG.....	672	82H.JP.....	447
503.....	515	640180RFID.....	885	779.PBT.....	674	82H.JU.....	444
504A.....	515	640180SLS.....	799	779.PBTSLS.....	803	83.AVSE.....	962
505A.....	513	64C.J2.....	215	779.PCA.....	670	830A.10.....	601
506A.....	512	64C.S.....	215	779.PEN.....	671	830A.10L.....	601
512.....	515	65.....	212	779.SILC.....	672	830A.10RN.....	601
513.....	514	65.RFID.....	857	779.SILR.....	672	830A.5.....	601
513A.7.....	514	65.F.....	810	779.TRIPOD.....	676	830A.5L.....	601
514.45R.....	516	65.SPL.....	213	779.UH.....	674	830A.5RN.....	601
514A.....	516	65.JP6.....	212	779.UVT.....	675	831.....	601
514A.R.....	516	65.JU6T.....	212	77A.PL.....	1125	832.....	601
514A.65.....	516	65.PE.....	284	77A.TO.....	1125	834.....	1010
517.....	514	65.PEF.....	814	780B.....	1072	834.R.....	1010
518.....	1151	65.PERFID.....	861	781.....	1071	834A.R.....	922
518A.J6.....	1137	660A.10SR.....	757	784B.....	1071	834B.RT.....	1010
518A.....	1137	668A.....	587	785.....	1071	834B.RTF.....	845
51B.....	238	669273.....	942	789.5.....	1188	834B.RTI.....	922
51BS.....	237	66A.....	249	793936.....	929	834B.RTIM.....	922
520A.....	516	673838.....	934	793940.....	929	834B.RTIR.....	922
521.....	516	678006.....	603	795A.....	538	834B.RTIS.....	922
54.MB.....	236	678006.....	947	796B.....	538	835.1.....	1007
54.MBSLS.....	783	678014.....	603	80.....	457	835A.....	1007
54.P9M.....	236	693695.....	946	80.JL7.....	457	837.....	442
54A.....	236	693716.....	946	800A.216.....	551	838.CX58.....	928
54A.SLS.....	783	697590.....	946	803.200MSLS.....	795	838305.....	941
55.AVSE.....	961	697602.....	946	803.300MSLS.....	795	839A.....	1016
55A.....	229	697611.....	946	804.....	1059	83H.....	450
55A.JD.....	230	697637.....	946	804.AM.....	1059	83H.JL.....	444
55A.JE.....	230	697645.....	946	804.L.....	1059	83H.JP9A.....	447

83H.JU10.....	444	871B.45.....	1149	985548.....	941
83R.JP6.....	447	872271.....	926	985753.....	935
83S.L.....	449	872271SLS.....	799	985755.....	938
83S.JP9AL.....	447	872A.....	1152	985756.....	938
83SH.....	449	874A.....	1149	985757.....	937
83SH.ST.....	451	875.....	1150	985758.....	939
83SH.JL.....	444	876A.....	1150	985761.....	930
83SH.JP.....	447	87H.JE8.....	445	985762.....	930
83SH.JP8UF.....	824	87H.JU8.....	445	985763.....	940
83SH.JP9F.....	825	87HL.JE8.....	445	985764.....	940
83SH.JU8.....	444	87HL.JU8.....	445	985765.....	940
83SHST.JP9.....	452	880.....	608	985894.....	1074
840.1.....	622	882A.....	609	985894.....	935
840.4A.....	621	882A.65.....	608	985895.....	937
840.F.....	620	883.32.....	608	985896.....	938
840.FRFID.....	885	883B.....	608	985899.....	938
840B.....	622	883B.G.....	608	985902.....	938
840LE.....	621	884.30.....	608	985905.....	937
841.....	620	884A.65.....	608	985912.....	613
841.MT.....	1005	884B.....	608	985913.....	936
841A.....	620	885.....	660	985914.....	936
841A.SLS.....	799	885.EH.....	661	985915.....	936
843.....	622	885.F.....	661	985916.....	936
844.D.....	615	887A.....	610	985917.....	936
844.DRFID.....	884	89.....	452	985918.....	936
844.DSLS.....	799	89.JA8.....	445	985919.....	936
844.R.....	616	89.JL.....	445	985920.....	936
844.S18.....	616	89.JP.....	447	985921.....	936
844.S18L10.....	618	891A.PL.....	1150	985922.....	936
844.S18RFID.....	884	893.316.....	1151	985923.....	936
844.S9.....	616	893.316FLUORFID.....	882	985925.....	613
844.S9L10.....	618	893.316SLS.....	796	985936.....	928
844.SE18.....	616	893.519SLS.....	796	985951.....	927
844.TCL10.....	618	893B.....	551	985952.....	927
844.TRL10.....	617	895A.....	1150	985953.....	927
844.TTL10.....	617	897A.....	550	985954.....	927
845.1.....	1006	89A.JM8.....	448	985955.....	927
848.P2.....	1015	89R.....	453	985956.....	927
848.P3.....	1015	89R.JM8.....	448	985957.....	927
848.P4.....	1015	89R.JP6.....	447	985962.....	928
848B.100.....	1015	89S.....	452	985964.....	928
84E.....	994	89S.JP8A.....	447	985966.....	935
84E.J1.....	998	89TX.SLS.....	790	985968.....	946
84TC.....	455	89TXA.....	454	985969.....	946
84TC.JE5.....	455	906A.....	1149	985972.....	946
84TC.D.....	456	908A.....	1152	985974.....	946
84TC.D.J6.....	456	909A.....	1149	985978.....	946
84TZ.SLS.....	789	911.....	1077	985984.....	946
84TZA.....	454	911-B2.....	1077	985995.....	946
84TZS.F.....	825	911-B5.....	1077	986014.....	939
84TZSA.....	453	911-B8.....	1077	986022.....	939
850.EF350.....	1150	911-C90.....	1080	986051.....	947
850.F350.....	1150	911-V10.....	1077	986058.....	930
850.S300.....	1150	911-V4.....	1077	986059.....	930
850.S350.....	1150	911-V5.....	1077	986075.....	940
850.SD350.....	1150	911-VA.....	1080	986095.....	1188
851B.....	1150	911B.FC.....	1078	986095.....	936
855367.....	933	912.....	1079	986107.....	947
859H.....	564	912-01-02.....	1080	98B.....	247
861D.....	1147	912.....	1079	990.B.....	611
861D.RPC.....	1147	916.600.....	1084	990.BF.....	610
862D.60.....	1148	920B.....	1088	990.BRF0.....	611
866D.32.....	1147	92A.....	243	990.LB.....	611
866D.41.....	1147	92A.JE8.....	243	990.LRB.....	611
867D.....	1148	92A.P16M.....	243	990.RB.....	611
867D.DS.....	1148	935A.....	1087	996.....	614
868D.40BOC.....	1147	947.....	1016	996A.....	614
868D.40PLD1.....	1147	947A.....	1016	99C.....	247
86H.JE.....	448	94A.....	246	99C.JE.....	248
86H.JE7AFRFID.....	881	94T.AVSE.....	962	99C.P12E.....	248
86H.JE7ASLS.....	789	94TL.AVSE.....	962		
86H.JE7BFRFID.....	881	97.....	244		
86H.JE7BSLS.....	789	97.JE6.....	244		
86H.JU.....	448	980.....	619		
86H.JU6FRFID.....	881	980C.....	619		
86H.JU7FRFID.....	881	982.....	609		
870A.....	1149	982.G.....	609		
870B.....	1149	985.....	609		

Catalogue printed with respect to the environment.



Design and production:

ÉVOLUTION
MC CANN
CIRSE
GRAPHEMES

Photography:

Melisse Brandaddictive
Petter Allan

Printing, finishing and binding:

Groupe Maury imprimeur

Photo credit

Shutterstock

- This catalogue supersedes all previous issues. All rights reserved in all countries. No part of this publication may be reproduced without our prior written consent.
- Printed in France.
- Copyright: 15/13/2018.
- Print run of this catalogue 319000 copies in 8 languages.
- In line with FACOM's* policy of continual product improvements to meet user needs and technological developments, all models and sets listed in this catalogue (photographs, specifications, sizes and weights) may be upgraded or discontinued without notice and without any obligation on our part to modify tools or equipment sold previously.
- Sections 01, 18, 21, and 23 show tool sets, the contents of which are listed in tables. Tool quantities (Qty) given for each reference

indicate the number of items included in the set. Set contents may be revised as product ranges are developed, or subject to availability.

- The recommendations for use and safety given in this catalogue do not replace accepted good practice or the safety-related legal and regulatory provisions.
- References to standards in force on the date of publishing of this catalogue are not contractually binding.
- Product performances quoted are based on tests carried out in FACOM* laboratories, and are not binding.
- FACOM* undertakes to continue to provide spare parts for its discontinued products for a period of two years following their removal from sale.

In the event that said parts become unavailable before the end of this two year period, FACOM* will propose an alternative solution.

*FACOM is a brand of the group Stanley Black & Decker.

Stanley Black & Decker, SAS au capital de 234 759 168 €, 954 507 521 RCS Lyon - 5, allée des Hêtres 69760 LIMONEST - N° TVA : FR28954507521.

Trademarks held by Stanley Black & Decker:

FACOM - FACOM Aerospace - FACOM Elec - FACOM MICRO-TECH - FACOM Technospace - Ergonomie FACOM - Couleur Bleu et rouge - Couleur Bleue - FACOM VSE 1000 VOLTS - Garantie FACOM - Service FACOM - L'Outillage FACOM - L'atelier Le Club des Pros - Borneo - CDX - Dela - Easotork - Enduro - Ergotwist - Jivaro - OGV - ProBlade - Profiber - Protwist - Serkan - Swingo - Toukan. '

Trademarks held by third parties:

Circlips by Nomel - **Tri-wing, Torq set** by Phillips Screw C° - **Pozidriv** by European Industrial Service - **Robertson** by Robertson Inc. - **Teflon** by E.I. Du Pont De Nemours - **Torx, Torx Plus, Resistorx** by Acument Intellectual Properties - **Truarc** by Truarc Cy.

CONTACTS

Germany

STANLEY BLACK & DECKER Deutschland GmbH
Geschäftsbereich FACOM
Black & Decker Str. 40
65510 Idstein
Tel. +49 (0) 6126 21 2922
Fax +49 (0) 6126 21 2114
verkaufde.facom@sbdinc.com
www.facom.de

Austria

STANLEY BLACK & DECKER Austria GmbH
Oberlaaerstrasse 248
A-1230 Wien
Tel. +43 (0) 1 66116-0
Fax. +43 (0) 1 66116-613
verkaufat.sbd@sbdinc.com
www.facom.com/at

Belgium

Luxembourg
Stanley Black & Decker BVBA
Divisie FACOM
Egide Walschaerstraat 16
2800 Mechelen
Tél. + 32 (0) 15 47 39 30
www.facom.be

Spain

Stanley Black & Decker IBÉRICA S.L.U
Parque de Negocios "Mas Blau"
Edificio Muntadas
C/Berguedá 1, Of. A6
08820 El Prat de Llobregat (Barcelona)
Tél. +34 93 479 74 00
Fax +34 93 479 74 19
facomherramientas@sbdinc.com
www.facom.es

USA

Stanley Black & Decker, Inc.
505 North Cleveland Ave
Westerville, OH 43082
Phone 800-800-TOOL
Fax 770-648-9108
www.facom.com

France

Stanley Black&Decker France SAS Marque FACOM
5, allée des Hêtres
69760 LIMONEST - France
Tél. 01 64 54 45 45
Fax 01 69 09 60 93
www.facom.fr

Renseignements techniques :

+33 (0)1 64 54 45 14

Du lundi au vendredi, de 8h à 12h30 et 13h15 à 18h.

Service outils spéciaux :

+33 (0)1 64 54 46 70

Fax : 33 (0)1 69 74 29 04

Du lundi au vendredi, de 8h30 à 12h30 et 13h15 à 17h.

International - Francophone Africa

Stanley Black & Decker France SAS | Marque FACOM
6/8 rue Gustave Eiffel - BP 99
91423 MORANGIS CEDEX - France
Tél. 01 64 54 45 45
Fax 01 69 09 60 93
www.facom.com
Afrique francophone : www.facom.com/afr
Algérie : www.facom.com/dz
Maroc : www.facom.com/ma
Tunisie : www.facom.com/tn

United Kingdom

Ireland
Stanley Black & Decker UK Limited
3 Europa Court Sheffield Business Park
Sheffield, S9 1XE
Tél. +44 1142 917266
Fax +44 1142 917131
www.facom.com/uk

Greece

Cyprus
Israel
STANLEY BLACK & DECKER (ΕΛΛΑΣ) ΕΠΕ
ΣΤΡΑΒΩΝΟΣ 7, ΓΛΥΦΑΔΑ TK 16674
Τηλ. 210 8981616
Fax 210 8983570
cssgreece2@sbdinc.com
www.facom.com

Hungary

Stanley Black & Decker Hungary Kft.
1016 Budapest
Mészáros utca 58/B
Tel: +36 1 214-6452
Fax: +36 1 214-6935
www.facom.com

India

Stanley Black & Decker India Private Limited
28, Akemps, 1st Cross,
Koramangala Intermediate Ring Road,
3rd Main Rd, Ashwini Layout, Ejjipura, Bengaluru,
Karnataka 560047
Tél. 080-67919900
SBD-CustomerCommunications@sbdinc.com www.
facom.com

Italy

Stanley Black & Decker Italia s.r.l.
Sede Operativa: Via Volta, 3 21020 Monvalle (VA) -
ITALIA
Tel. +39 0332 790 111
Fax. +39 0332790 363
facom@mygts.net
www.facom.com/it

The Netherlands

Stanley Black & Decker Netherlands BV
FACOM Netherlands
Postbus 83
6120 AB Born
Nederland
Tél. 0800 236 236 2
www.facom.nl

Poland

Stanley Black & Decker Polska Sp. z o.o
ul. Prosta 68, 00-838 Warszawa
Tél.+48 22 46 42 700
Fax +48 22 46 42 701
info@facom.pl
www.facom.pl

Latin America

FACOM S.L.A
9850 Premier Parkway
Miramar, Florida 33025 USA
Tél. +1 954 624 1110
Fax +1 954 624 1152
www.facom.com

Middle East - Anglo- phone Africa

Stanley Black & Decker MEA FZE
P.O.262375, Jebel Ali Free Zone
(South)
Dubai, United Arab Emirates
Tél. +971 48 12 73 00
Fax. +971 48 86 33 33
Email: Facom-mea@sbdinc.com
www.facom.com

South East Asia, South Korea, Indonesia, Malaysia, Thailand

The Stanleyworks (Shanghai) Co.
Ltd8/F, Lujiazui Fund Tower
No.101, Zhulin Road PuDong District
Shanghai, 20122, China
Tél. 8621-6162 1858
Fax 8621-5080 5101
www.facom.com

Portugal

Stanley Black & Decker Holding s.a.r.l.
Sucursal em Portugal
Quinta da Fonte - Edifício Q55 D. Diniz, Rua dos Mal-
hães, 2 e 2A - Piso 2 Esquerdo
2770 - 071 Paço de Arcos - Portugal
Tél. +351 214 667 500
Fax +351 214 667 580
facomherramientas@sbdinc.com
www.facom.com/pt

Czech Republic

Slovakia
Stanley Black & Decker Czech Republic s.r.o.
Türkova 5b
149 00 Praha 4 - Chodov
Tél. +420 261 009 780
Fax +420 261 009 784
www.facom.com/cz

Romania

Stanley Black&Decker Romania
Phoenicia Business Center
Turturelelor Street, No 11A, 4th Floor, Modules 12-15
Phone: +4021.320.61.04
Fax: +4037.225.36.84
www.facom.com

Russia

Stanley Black&Decker LLC
ул. Обручева 30/1, стр.2
117485, Москва
Tél. +7 495 258 3981/2/3
Fax +7 795 258 3984
www.facom.com/ru



Scandinavia

Stanley Black & Decker
Fljölbergsgatan 1C
SE-431 35 Mölndal, Sweden
Tel. +45 70201510
Tel. +46 (0)31 68 60 60
Tel. +47 4525 0800
Tel. +358 (0)10 400 4333
facom-nordic@sbdinc.com
www.facom.com

Switzerland

Stanley Works Europe GmbH
Sitz: Dübendorf
In der Luberzen 42
CH-8902 Urdorf
Tél. +41-44-755-60-70
Fax: +41-44-755-70-67
E-mail: verkaufch.sbd@sbdinc.com
www.facom.com/ch



www.facom.com